



**Response-2000**  
**Shell-2000**  
**Triax-2000**  
**Membrane-2000**



# User Manual



Copyright © Evan Bentz and Michael P. Collins, September 2001  
Version 1.0 March 2001  
Version 1.1 September 2001

## Introduction

This manual covers the details of operation of the following programs:

Membrane-2000	2D Sectional analysis of membranes
Response-2000	2D Sectional analysis of beams and columns
Triax-2000	3D Sectional analysis of general concrete blocks
Shell-2000	3D Sectional analysis of plates and shells

Each of these programs is a non-linear sectional analysis program for the analysis of reinforced concrete elements subjected to shear based on the Modified Compression Field Theory<sup>1</sup>. These programs were written over the years 1996-1999 by Evan Bentz, PhD candidate at the University of Toronto under the supervision of Professor M. P. Collins. Together they represent over 150,000 lines of C++.

The following guiding principles were used in designing these applications. They were to allow fast checking for errors in input and fast interpretation of results with ample graphics. They were to provide stable, state-of-the-art analysis techniques and, finally, they were designed to leave the user knowing more about the real behaviour of concrete rather than less, as some computer programs seem to do.

Each of the programs has a similar “look and feel” and has been designed to be as intuitive as possible. This manual acts as an explicit explanation of what the programs can do and how to make them do it. This manual does not attempt to provide any of the background into the analysis techniques used, as this is covered elsewhere<sup>2</sup>.

**Section I** of the manual provides a “quick start” type of description of how to make simple input files for each of the programs as well as how to interpret the results.

**Section II** follows with a more detailed description of creating input geometry for each program.

**Section III** defines the loading options.

**Section IV** explains the types of analysis possible and explains the output from each main screen of the program.

**Section V** provides a description of some of the more advanced options that allow customisation of the program.

Membrane-2000 Response-2000 Triax-2000 Shell-2000

---

These programs are available for no charge from the World Wide Web at the following addresses:

<a href="http://www.ecf.utoronto.ca/~bentz/r2k.htm">http://www.ecf.utoronto.ca/~bentz/r2k.htm</a>	Response-2000
<a href="http://www.ecf.utoronto.ca/~bentz/m2k.htm">http://www.ecf.utoronto.ca/~bentz/m2k.htm</a>	Membrane-2000
<a href="http://www.ecf.utoronto.ca/~bentz/t2k.htm">http://www.ecf.utoronto.ca/~bentz/t2k.htm</a>	Triax-2000
<a href="http://www.ecf.utoronto.ca/~bentz/s2k.htm">http://www.ecf.utoronto.ca/~bentz/s2k.htm</a>	Shell-2000

For further details or for help in using the programs, contact the author at:

Evan Bentz  
Assistant Professor  
Department of Civil Engineering  
University of Toronto  
Toronto, Ontario Canada  
M5S 1A4  
[bentz@ecf.utoronto.ca](mailto:bentz@ecf.utoronto.ca)

Table of Contents

Introduction.....	2
SECTION I: Quick Start.....	7
Program Installation .....	7
Quick Start: Membrane-2000 .....	7
Quick Start: Response-2000 .....	10
Automatic Cross-Section.....	11
Analysis.....	12
Member Response .....	13
Quick Start: Triax-2000.....	16
Quick Start: Shell-2000 .....	18
SECTION II: How to make Input Files .....	20
2-1 Quick Define Wizard .....	20
Membrane-2000 / Shell-2000 / Triax-2000 Wizard.....	20
Response-2000 Wizard .....	21
2-2 Defining General Information.....	23
2-3 Materials Definition .....	24
Basic Properties Page.....	24
Concrete Detailed Definition .....	25
Table 2-1 Concrete Material Properties, Meanings and Default Values.....	26
Reinforcement Detailed Definition .....	27
Table 2-2 Reinforcement Material Properties Meanings and Default Values .....	28
Prestressing Steel Detailed Definition.....	29
Table 2-3 Prestressed Reinforcement Material Properties, Meanings and Default Values.....	29
2-4 Concrete Cross Section .....	30
Response-2000 Concrete Cross Section Definition .....	30
2-5 Longitudinal Reinforcement .....	32
Individual Layers.....	32
Table 2-4 Reinforcing Bar and Strand Designations .....	33
Distributed Layers Pattern.....	35
Tendon Layers.....	36
Triax-2000 .....	36
2-6 Transverse Reinforcement.....	37
2-7 Element Catalog .....	38
SECTION III: Loading and Analysis Options.....	39
3-1 Membrane-2000 .....	39
Loading.....	39
Shrinkage and Thermal Strains .....	39
Experimental Results.....	39
3-2 Triax-2000.....	40
Loading.....	40

Membrane-2000 Response-2000 Triax-2000 Shell-2000

---

Shrinkage and Thermal Strains .....	40
3-3 Shell-2000 .....	41
Loading.....	41
Shrinkage and Thermal Strains .....	41
3-5 Response-2000 .....	42
Loading.....	42
Time Dependent Effects.....	42
Detailed Shrinkage and Thermal Strains.....	43
Strain Discontinuity.....	44
Full Member Properties.....	44
SECTION IV: Analysis and Interpretation.....	46
4-1 General Information .....	46
4-2 Types of Analyses .....	47
4-3 Membrane-2000 .....	48
Membrane-2000: 9 Plots General .....	48
Membrane-2000: 9 Plots Mohr's Circle.....	50
Membrane-2000: 9 Plots Rebar and Cracks.....	51
4-4 Response-2000 .....	53
Response-2000 9 Plots General.....	53
Response-2000 9 Plots Cracking.....	55
Response-2000 9 Plots Reinforcement .....	55
Response-2000 9 Plots No Shear .....	57
Response-2000 Load Deformation Plots.....	58
Other Load-Deformation Plots.....	60
Response-2000 Full Member Plots .....	60
4-5 Triax-2000.....	62
Triax-2000 9 Plots General .....	62
Triax-2000 Other 9-plot Views .....	63
4-6 Shell-2000 .....	65
Shell-2000 9 plots General.....	65
Shell-2000 9-Plot Views .....	67
Shell-2000 Interpreting Crack Diagrams .....	68
Shell-2000 Load-Deformation Plots .....	69
SECTION V: Advanced Topics.....	70
5-1 Text Effects .....	70
5-2 Chart Options .....	70
5-3 Edit Chart Properties .....	71
Title Section .....	71
Scaling of Data Section.....	71
Line Section.....	72
5-4 Double Click Information in Response-2000.....	72
5-5 Segmental Concrete Model .....	72
5-6 Material Reduction Factors .....	72
5-7 Concrete Strain Discontinuity Example.....	73

Membrane-2000 Response-2000 Triax-2000 Shell-2000

---

5-8 Rebar.dat .....	75
5-9 Adding predefined shapes: Shape.dat .....	76
5-10 Adding predefined sections: Standard.dat.....	77
5-11 Template Files.....	78
5-12 Text File Formats .....	79
References.....	83

## SECTION I: Quick Start

This section gives a quick introduction to each program in terms of what they can do with an example to show how to do it.

### Program Installation

To install the programs from this manual, simply copy them into a new directory and unzip the zip files. Consult your Microsoft Windows manual to find how to make a shortcut to the program or to add them to the start menu.



## Quick Start: Membrane-2000

Membrane-2000 is the simplest of the four programs described in this manual. It allows analysis of reinforced concrete shells subjected to in-plane forces (axial force in X and Y directions and in-plane shear). Internal reinforcement may be in orthogonal directions X and Y with an arbitrary number of bar layers and spacing allowed.

Membrane elements subjected to in-plane forces can be found in structural walls, the webs of beams, containment vessels, and cooling towers amongst many others. This is the type of experimental element tested to develop the modified compression field theory. To demonstrate the program, one of these original elements, Vecchio's PV20, tested in pure shear in 1981<sup>3</sup>, will be examined.

By default, membrane-2000 starts with PV20 loaded, so to see the element after

Membrane Properties		
	X-Dir'n	Y-Dir'n
$A_s$ (mm <sup>2</sup> /m)	1267	628
$\rho$ (percent)	1.810	0.897
$\rho f_y$ (MPa)	8.32	2.66
Crack Space (mm)	107	115

<p><u>Concrete shrinkage strain:</u></p> <p>0.00 mm/m</p> <p><u>Loading (<math>N_x, N_x, V_{xy} + dN_x, dN_y, dV_{xy}</math>)</u></p> <p>0.00, 0.00, 0.00 + 0.00, 0.00, 1.00</p>		<p><u>X-Reinforcement</u></p> <p>2 layers of <math>A_s = 32 \text{ mm}^2 @ 50 \text{ mm}</math></p>	<p><u>Y-Reinforcement</u></p> <p>2 layers of <math>A_s = 16 \text{ mm}^2 @ 50 \text{ mm}</math></p>
--	--	---	---

<p><b>Concrete</b></p> <p><math>f'_c = 19.6 \text{ MPa}</math></p> <p><math>a = 6 \text{ mm}</math></p> <p><math>f_t = 1.48 \text{ MPa (auto)}</math></p> <p><math>\epsilon'_c = 1.86 \text{ mm/m}</math></p>	<p><b>Rebar</b></p> <p><math>f_u = 552 \text{ MPa}</math></p> <p>x-steel, <math>f_y = 460</math></p> <p>y-steel, <math>f_y = 297</math></p> <p><math>\epsilon_s = 100.0 \text{ mm/m}</math></p>	<p>All dimensions in millimetres</p> <p>Minimum clear cover : 6 mm</p>
---	---	--

	<b>PV20</b>
<b>Vecchio University of Toronto</b>	

Membrane-2000 Response-2000 Triax-2000 Shell-2000

starting the program, simply click on the cross section icon in the toolbar, which looks like a little membrane element or select the menu option “View | Cross Section”. The figure shown above is a direct print of the page that will appear.

The drawing attempts to document all the input parameters of the model to allow for easy error checking or quick documentation of a design. The properties shown on the page may be changed using the “define” menu. Additionally, double clicking on the drawing itself allows easy access to the define menu. For example, to change the stress-strain properties of the reinforcement in the X direction, it is possible to go to the “Define | Materials” menu option, or simply to double click on the drawing near the stress-strain line of the x-steel.

As this membrane element is already defined, an analysis may be performed immediately. Membrane-2000 allows 3 different analysis types to be performed. The simplest is a strain state analysis whereby the stress-resultants from a given strain state ( $\epsilon_x, \epsilon_y, \gamma_{xy}$ ) will be calculated. The second type of analysis solves to the strain state that corresponds to a selected load state ( $N_x, N_y, V_{xy}$ ). The final analysis, “full response”, is the most common. This will calculate the full load-deformation history for the element. Clicking on the “mcf” button in the toolbar will perform an analysis based on the Modified Compression Field Theory<sup>1</sup>.

The screen will change to a 9-plot view as shown below. This is a standard view for the

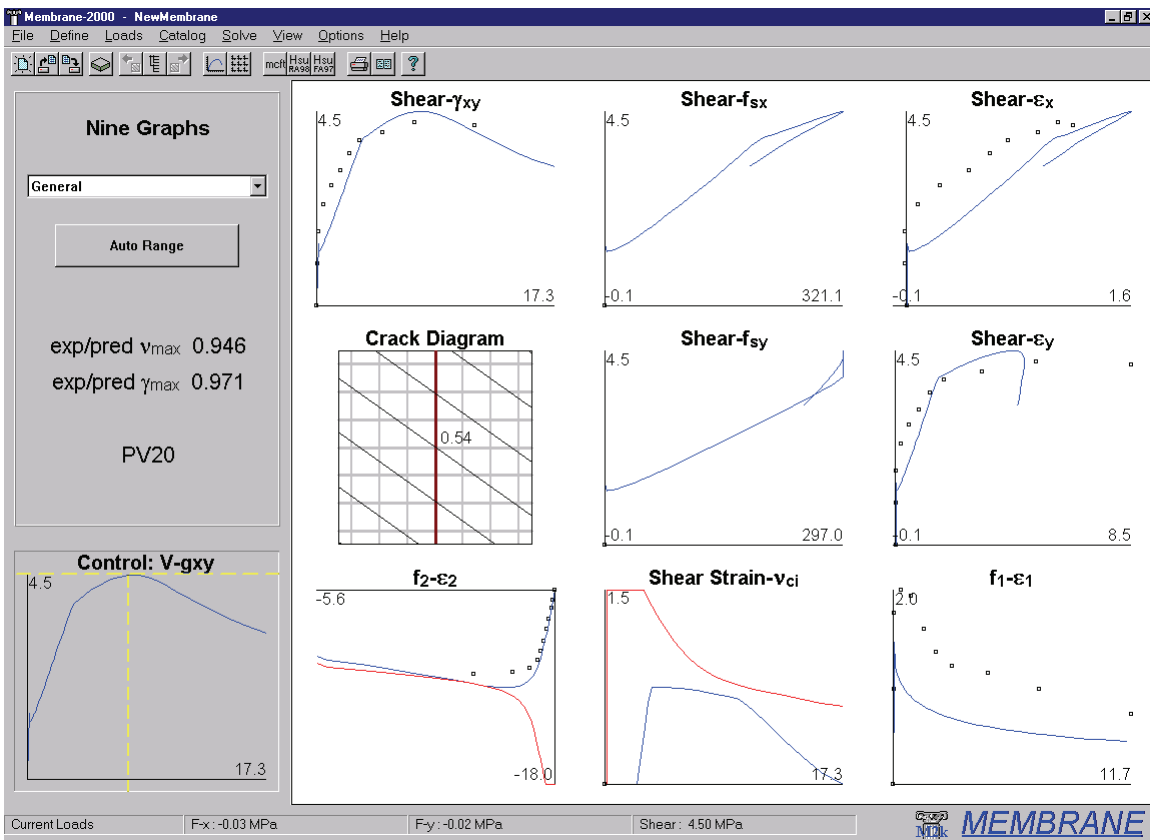

Membrane-2000 9-plot output



programs explained in this manual. Each plot represents one variable of the solution for the panel PV20. For Membrane-2000, each plot is a full load-deformation plot. Some of the experimental data from the test<sup>3</sup> are included as well for comparison.

Each of the programs in this manual will work with either SI metric, US customary units, or kg/cm<sup>2</sup> units as used in, for example, Japan. By default, the programs start up in SI metric (See Section 5-11 for information on how to change the default start units). The units may be changed in the “Options | Preferences” menu. For this example, stresses are in MPa, and strains are in parts per thousand ( $\times 10^{-3}$  or mm/m).

On the left of the screen is a “control plot.” It has crosshairs showing the currently selected load stage. This is the state that the crack diagram represents, with the crack width shown in mm. The red vertical line on the crack diagram indicates that the steel is yielding on average in the Y direction at this load level. Clicking with the mouse on the control plot, or using the Page-Up and Page-Down keys allow changing of the current load stage.

Also on the left, at the top, is a list-box that allows selection of which group of nine plots to examine. By default, the “General” page shows up. Another page shows Mohr’s circles and a list of the full stress and strain state of the element.

To examine the data more closely from one of the plots, it is possible to right-click on the plot and select “view data.” This allows the data to be copied to another application such as a spreadsheet to check to the data or make other plots.

An analysis like this generally takes less than one tenth of a second. It becomes possible to quickly find the effects of different reinforcing levels, for example, this way. See the later parts of this manual for more information on Membrane-2000.



## Quick Start: Response-2000

Response-2000 is perhaps the most immediately useful of the four programs explained in this manual. It allows analysis of beams and columns subjected to arbitrary combinations of axial load, moment and shear. It also includes a method to integrate the sectional behaviour for simple prismatic beam-segments. The assumptions implicit in the program are that plane sections remain plane, and that there is no transverse clamping stress across the depth of the beam. For sections of a beam or column a reasonable distance away from a support or point load, these are excellent assumptions. These are the same locations in beams that are usually the critical locations for brittle shear failures.

Unlike the other programs, Response-2000 doesn't have a default cross section entered into it. This isn't a real problem, however, as one can be made quickly. For this example, an 80 foot span prestressed concrete bridge girder and slab will be analysed.

First, as this example is presented with US customary units rather than the default SI metric, select it from the "Options | Preferences" dialog box. To select US units as a default each time the program begins, see section 5-11 of this manual.

Secondly, go to the "Define | Quick Define" dialog box. This is a "wizard" that allows a section to be created quite quickly, usually within 30 seconds. Each of the four programs in this manual has such a wizard to make new files quickly.

The first page of the dialog box asks for a title and material properties. After entering a title, say, "Test Section" with the reader's initials for the "Analysis by" box, the material properties may be selected. For this example, the 5000 psi concrete, 60 ksi steel and 270 ksi strands are fine, so select the "Next" button.

The second page of the wizard asks for the concrete cross section. At the top of the list are simple sections such as rectangles and circles. In the middle of the list are more exotic shapes such as columns with interlocking hoops, and hollow columns. At the bottom are the "standard shapes" such as AASHTO girders. As this is what is needed here, scroll down near the bottom of the list and select "Standard Shapes AASHTO". Press tab (or click with the mouse) to the right side to select the type of section. Pressing any key will pop up a selection box to select a section from the currently defined listings. Select the AASHTO Type IV girder and press "ok". For the next input field, enter zero, as there will be no "haunch" on this section (i.e., no extra concrete between the top of the precast beam and the bottom of the slab.) Select a slab depth of 8 inches, and a slab width of 80 inches, and select Next to go to the next page of the wizard.

The third page allows selection of the longitudinal reinforcement for the section. The top half defines bars in the slab for this standard cross section case and the bottom

Membrane-2000 Response-2000 Triax-2000 Shell-2000

defines non-prestressed steel in the bottom of the cross section. Leave the default of 20 #4 bars for the top, but remove the 3 #8 bars for the bottom by entering “0” for the number of bars in the bottom half of the screen. Press the Next button again to go to the last page of the quick menu.

The last page allows selection of the stirrups as well as the strands. Select “open stirrup” from the list of stirrup types. The default bar type of #4 is reasonable. Select a spacing of 16 inches. Switch the clear cover to 2 inches from the default value, which is actually 40 mm converted to inches. Finally, enter 30 for the number of strands. The prestrain listed as 6.5 represents a jacking stress of 70% of ultimate, and is therefore reasonable. Select the “Finish” button to complete the definition of the section.

*Automatic Cross Section*

Response-2000 will automatically create the cross section as shown below similar to the one from Membrane-2000. As with the other programs, changing the geometry is achieved either through the use of the “define” menu or by double clicking on the drawing itself. For example, to change the stirrup spacing, double click on the text in the drawing where it says “#4 @ 16.00 in.” Like all the programs, this page is meant to include all the information needed to repeat the analysis or document it in the course of a design.

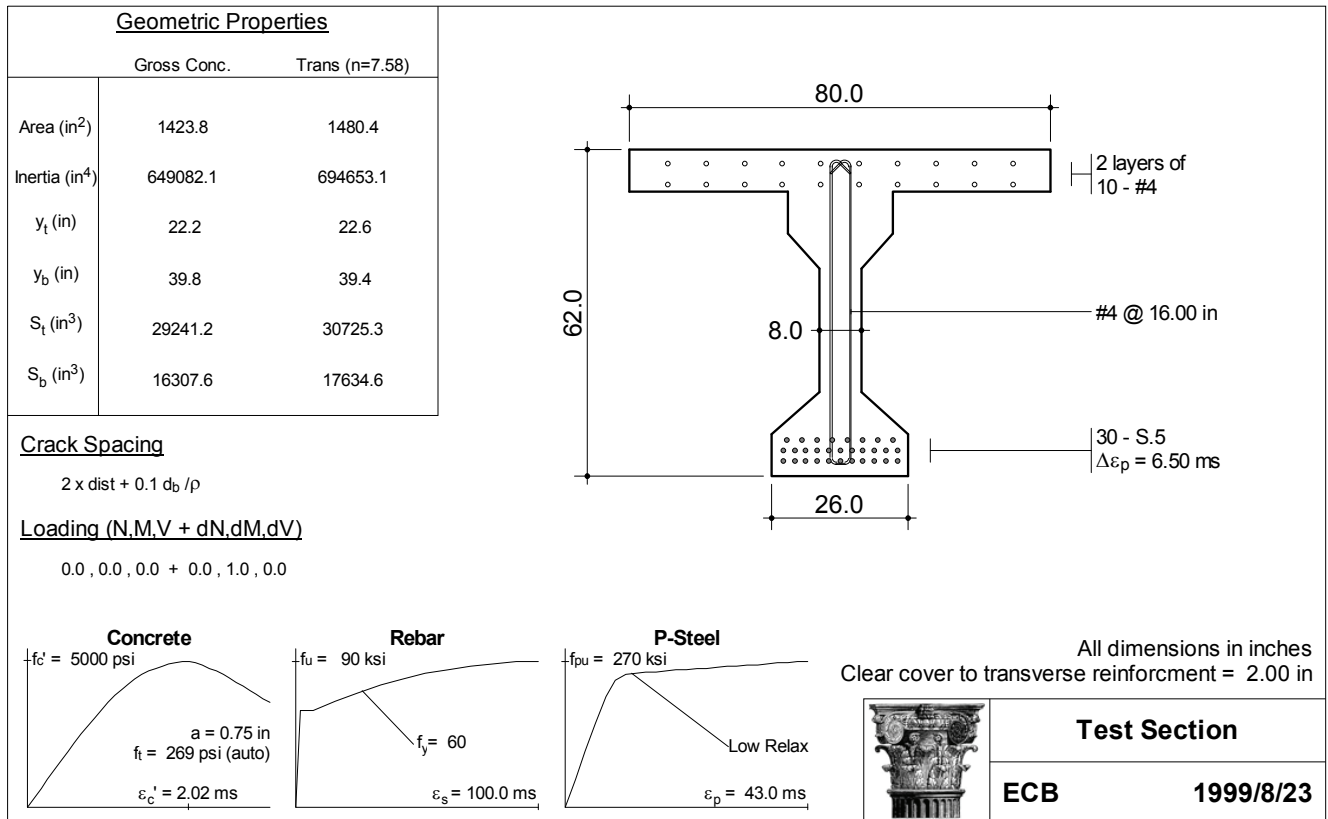

*Analysis without Shear*

The default type of analysis for a new section is a simple flexural analysis with no axial load. To start it, select “Solve | Sectional Response” from the menu. The analysis should take perhaps two seconds to complete. The control plot will show up along with 9 plots as in Membrane-2000. In the case of Response-2000, the plots all represent the given variable plotted over the depth of the section for the load stage indicated by the control plot. Click on the “Auto Range” button on the top left of the screen below the menu to automate the scale of the plots, and click anywhere on the control plot. All the plots will automatically change depending on the new location on the control plot. Note that the loading is listed in the bottom bar of the program window. The crack diagram shows predicted crack widths in inches as well as an estimate of the pattern of cracking.

*Analysis with Shear*

A more involved analysis type, one that Response-2000 excels at, is the prediction of sectional behaviour including the effects of shear. For a beam like this, it may be decided to perform an analysis at a location ‘d’ from the end of the beam. At a uniformly applied load of 3.0 kips/ft, the moment and shear at this location are about 435 kip.ft and 109 kips respectively. These loads are entered into the Response-2000 “Loads | Loads” menu option. This menu has a left and right side, where the left is for initial loads and the right is for any increment in load beyond that level. Leave the left values as zero and set the right side value for moment to 435 kip.ft and shear value to 109 kips. Note that the actual numbers here don’t matter, only the ratios and signs. After clicking the “ok” button, select “Solve | Sectional Response” to start the analysis.

The analysis should take about 10 seconds to reach the peak load, and then about 20 more seconds to determine the post-peak ductility for the section. The following 9-plot screen will show up. These plots represent the state of the beam at failure, as shown by the location of the crosshairs on the control plots. Each plot is drawn with respect to the depth of the section. For example, the top centre plot shows the longitudinal strain versus depth for the section showing the basic assumption that plane sections remain plane.

Briefly, the cross section in the top left is drawn darker in regions where it is predicted not to have cracked. In this case, only the web of the beam is predicted to be cracked at the shown failure load. The top right shows the variation in transverse strain over the depth, with a maximum of 7 mm/m near the top of the web. The crack diagram shows the predicted angle and width of cracks in inches. The shear stress plot shows that the shear is not uniformly distributed over the depth of the section, though is fairly constant in the web at about 630 psi.

## Membrane-2000 Response-2000 Triax-2000 Shell-2000

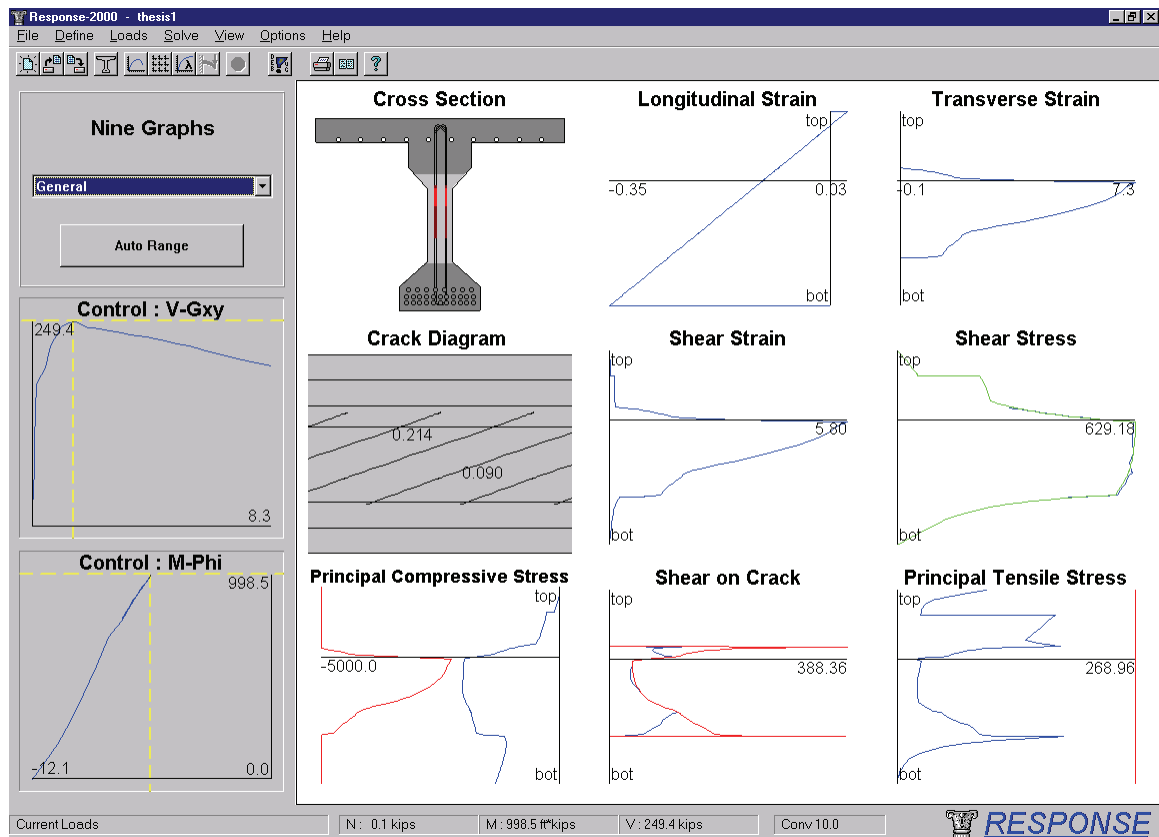

The bottom left plot of the 9 plots shows the principal compressive stress values. The line at the left of the plot is the maximum allowed stress versus depth and the right line shows the applied stress. Note the shear has applied an additional diagonal compression in the web on top of the expected concrete stress profile from the prestressing force. The two lines on this plot are about to touch at the top of the web indicating that this section is about to fail by crushing of the web.

The two control plots show that the “V-Gxy” curve, that is, the shear-shear strain plot, is descending with increasing shear strain, whereas the lower moment curvature plot is unloading along its loading curve. This indicates that the section is predicted to fail in shear. The maximum predicted shear capacity of the section is 249.4 kips. By scaling this from the loading, it is predicted that the beam would fail in shear at this location if the applied load were to increase to a level of 7.0 kips/foot.

### Member Response

Response-2000 will calculate the full member behaviour for a prismatic section as well. To get a prediction of the behaviour of this 80-foot beam, such an analysis will be performed with the beam subjected to a uniformly distributed load. First select the “Load | Full Member Properties” menu option. Select the “length subjected to shear” at the top as 480 inches. (The analysis is done from one end to the mid-span of the beam.) Also select in the top options a uniform distributed load rather than a constant shear analysis.

Membrane-2000 Response-2000 Triax-2000 Shell-2000

This is the second option in the top list of three buttons. Click “ok” and select the “Solve | Member Response” option.

This analysis will calculate an entire Moment-Shear interaction diagram and determine the load-deflection properties and crack diagram for the entire 40 foot half span of the beam. The analysis on an inexpensive 400 MHz Pentium II takes about 60 seconds to complete. As the analysis continues, the growing M-V interaction diagram will be shown on the control plots. Periodically, the 9 plots will also update showing the sectional behaviour at the location of the crosshairs on the control plots. The transition from flexural failures under positive moment at the right of the interaction diagram gives way to shear failures at the top of the interaction diagram and then back to flexural failures under negative moment at the left side. By clicking on the little squares on the plot, any of the integration points may be examined so see how the beam is behaving at that load combination.

When the analysis is complete, the screen will change to the deflection page as shown below. The top diagram is the predicted crack pattern at failure for the entire 40 foot section of beam. The bearing support plate at the left bottom can be seen, and the right side represents the midspan of the beam. Estimated crack widths are shown in inches. In the top control plot at the left is the M-V interaction diagram as well as the applied loading for this beam shown in red. For a uniformly distributed load, such as this, the majority of the loading is a parabola, with the load cut down to zero near the support due to non-sectional load resistance methods. The explanation for the shape of

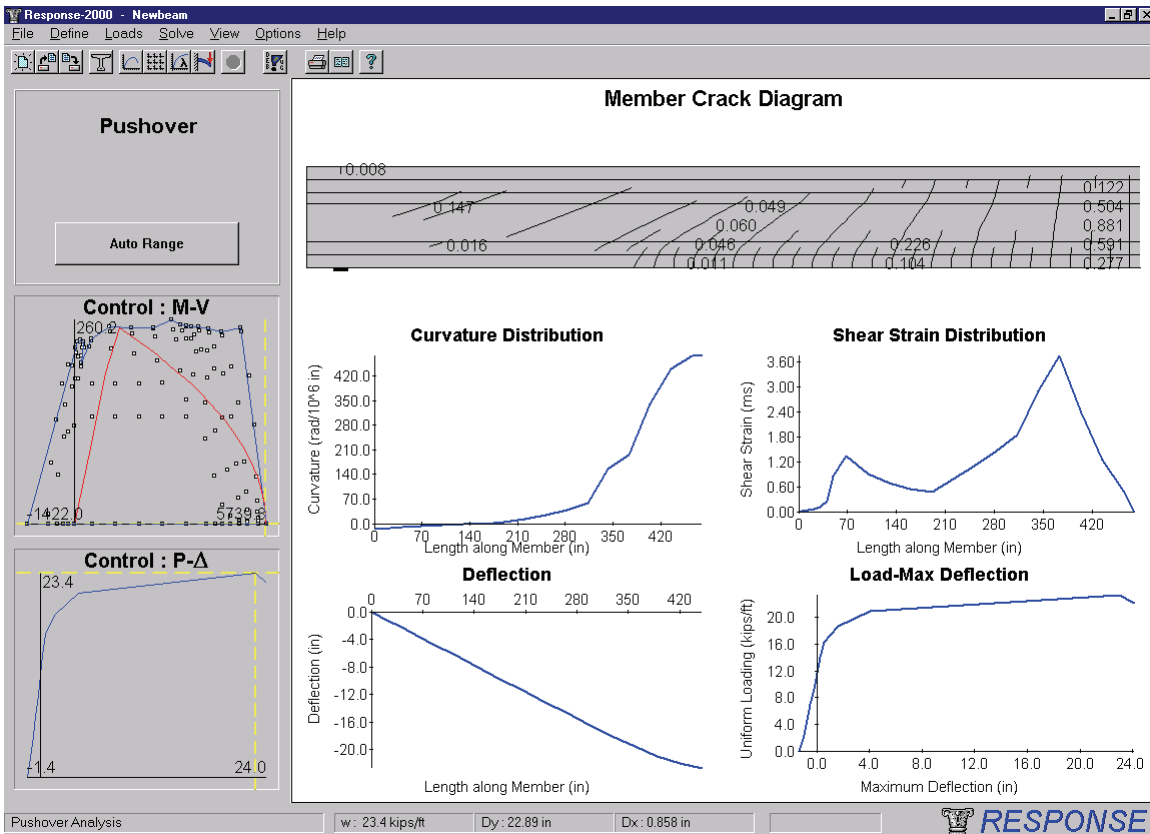

this load diagram can be found in reference 2. It can be seen from the interaction diagram that the loading envelope is touching the strength envelope almost simultaneously at the right side bottom (flexure in positive moment at midspan), as well as at the top (shear near support). Indeed, the midspan cracks are predicted to be almost 1 inch wide, and there is substantial shear cracking (0.147 inch cracks) near the support.

The bottom control plot shows the predicted load-deflection relationship for the beam (pushover analysis results for column analyses). The final behaviour is predicted to be fairly ductile, with a 22.9 inch deflection at a failure load of 7.13 kips/foot. Assuming that the load capacity is acceptable, this would seem to be a fairly efficient design in terms of shear versus flexural capacity; more stirrups would not be needed, as the beam would fail in flexure first. A lower amount of stirrups would subject the beam to a potentially brittle shear failure, however. In a design like this, it may be wise to err on the conservative side of shear design, however, and include a little bit more shear reinforcement than what has been provided. Of course Response-2000 allows any such option to be quickly checked by changing the spacing of the stirrups, and quickly rerunning the analysis.



## Quick Start: Triax-2000

Triax-2000 is a program for the analysis of a three dimensional block of concrete. This program is analogous to Membrane-2000 in three dimensions. Such a block of concrete can be thought of as a 3D brick finite element. The relatively complex interactions of non-linear 3D stress-strain behaviour can be efficiently examined with Triax-2000. Additionally, the program may be considered as a model for well reinforced 3D locations such as beam-column joints. It could be fairly argued that Triax-2000 is of more of an academic value than the other three programs

Loading for Triax-2000 consists of axial forces in the directions, X, Y, Z as well as shear on the X-Y, Y-Z and X-Z planes.

The program has a default section built into it as shown below. As it is a 3D sectional analysis, the block has no physical dimensions, but is assumed to be of sufficient size in all three dimensions to cover a series of cracks.

Element Properties			
	X-Dir'n	Y-Dir'n	Z-Dir'n
ρ (percent)	1.000	0.500	0.500
ρf <sub>y</sub> (MPa)	4.00	2.00	2.00
Crack Space (mm)	541	509	509

Concrete shrinkage strain:  
0.00 mm/m

Loading (dNx,dNx,dVxy + dVxy,dVxz,dVyz)  
0.00, 0.00, 0.00, 1.00, 0.00, 0.00

**Concrete**

f<sub>c'</sub> = 40.0 MPa

a = 10 mm

f<sub>t</sub> = 1.97 MPa (auto)

ε<sub>c'</sub> = 2.10 mm/m

**Rebar**

f<sub>u</sub> = 480 MPa

z-steel, f<sub>y</sub> = 400

x-steel, f<sub>y</sub> = 400

y-steel, f<sub>y</sub> = 400

ε<sub>s</sub> = 100.0 mm/m

Z-Reinforcement  
10M @ 0.500 percent

X-Reinforcement  
20M @ 1.000 percent

Y-Reinforcement  
10M @ 0.500 percent

All dimensions in millimetres

<b>Triax-2000</b>
<span>t2k</span> <span>t2k</span>

It's a rather arbitrary loading, but an analysis will be performed on the shown section with the following load ratios:

Load Direction	N <sub>x</sub>	N <sub>y</sub>	N <sub>z</sub>	V <sub>xy</sub>	V <sub>yz</sub>	V <sub>xz</sub>
Load Ratio	1.0	2.0	3.0	4.0	5.0	6.0



Membrane-2000 Response-2000 Triax-2000 Shell-2000

This loading represents triaxial tension on the element as well as increasing shear in all shear directions. These load ratios are entered into the program by selecting the “Loads | Loads” menu option. As in each of the programs explained in this manual, there are two columns of numbers that may be entered. The left column is for the load level to start the analysis at, and the right column is for the loading ratios to be used for incrementing load after that point. Note that the actual values on the right column don’t matter, only their relative values and signs are used in the program. Enter the above load levels into the right side column of the loads menu and close the loads dialog box by clicking the “ok” button.

On clicking the “solve” button on the toolbar, the now familiar 9 plots show up with the results of the analysis as shown below. The control plot is automatically selected by the load ratios and in this case shows the load-factor vs shear strain in the Y-Z direction.

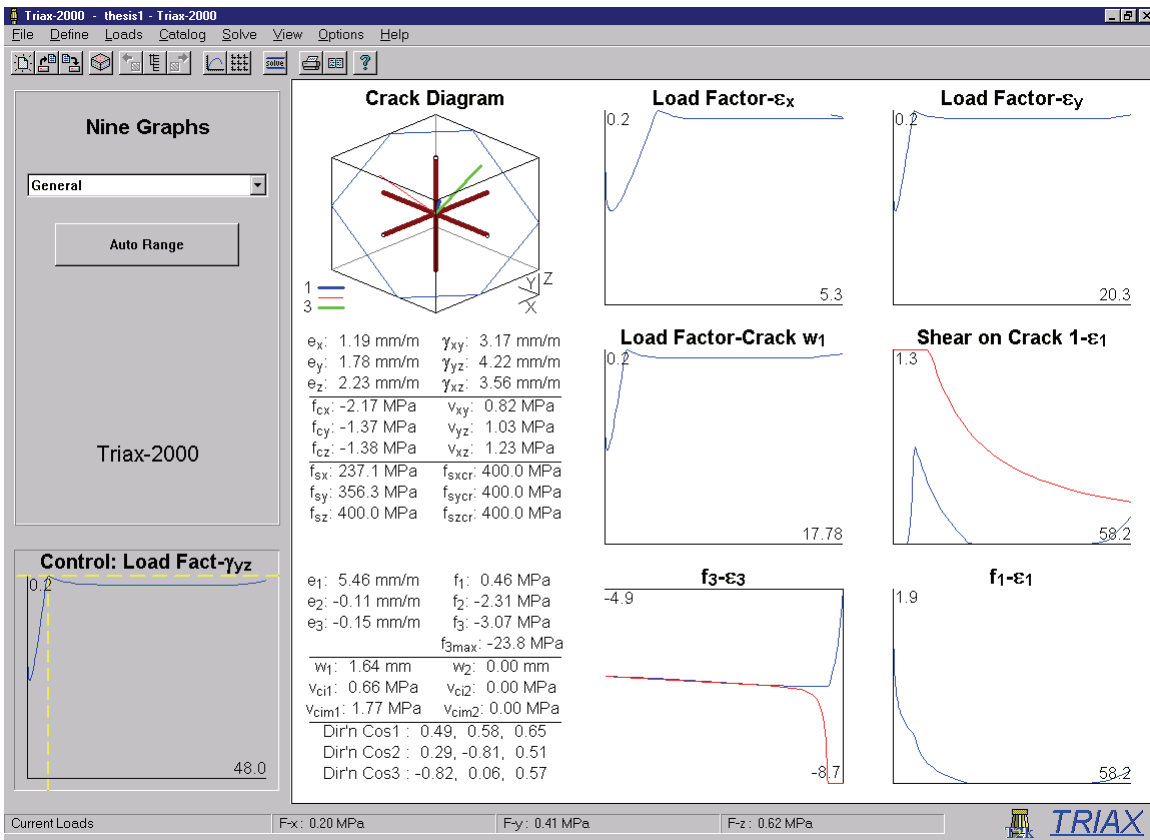

Triax-2000 9-plot output

Triax-2000 shows a tabular list of all the strain and stress state for the element at the load the crosshairs on the control plot point at. The crack diagram shows the principal directions as well as the intersection of the crack planes with the outside of the concrete volume. In general, 3D behaviour of this type requires some study to ensure that the results are indeed what is expected.

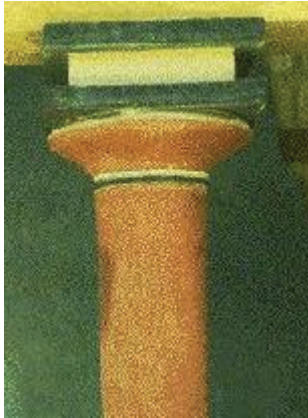

## Quick Start: Shell-2000

The last of the four programs in this manual is Shell-2000. It assembles a collection of Triax-2000 elements on top of each other to allow out-of-plane analyses of plates and shells to be performed. As such, it is a three dimensional analogue of Response-2000. It is also a more general version of Membrane-2000 that will allow analysis that includes out of plane forces. Shell elements like this can be found in slabs and walls and, indeed, almost all structures made of plates or shells.

Loading for Shell-2000 consists of the following 8 force resultants: Axial force in X and Y directions, moment about X and Y axes, out-of-plane shear about X-Z and Y-Z planes, twisting moment ( $M_{xy}$ ) and in-plane shear. Shell-2000 is a superset of Membrane-2000 and can do all analyses that Membrane-2000 can do. Due to the inherent 3D nature of the implementation, however, it is slower than Membrane-2000.

The default element in Shell-2000 is the shell element SE4 tested by Kirschner from the original series of tests in the University of Toronto shell element tester tested in 1984<sup>4</sup>.

Shell Properties		
	X-Dir'n	Y-Dir'n
$A_s$ (mm <sup>2</sup> /m)	8333	2778
$\rho$ (percent)	2.924	0.975
$\rho f_y$ (MPa)	14.39	4.67
Crack Space (mm)		

<p><u>Concrete shrinkage strain:</u></p> <p>0.00 mm/m</p>		<p><u>Concrete shrinkage strain:</u></p> <p>0.00 mm/m</p>
---	--	---

<p><u>Loading (Constant + Increment)</u></p> <p>0.00, 0.00, 0.00, 0.00, 0.00, 0.00, 0.00, 0.00 + 0.00, 0.00, 1.00, 0.50, 0.00, 0.00, 0.00, 0.00</p>	<p><b>Concrete</b></p>	<p><b>Rebar</b></p>	<p>All dimensions in millimetres Minimum clear cover : 11 mm</p>
---	------------------------	---------------------	--

  

	<b>SE4</b>
<b>Kirschner University of Toronto</b>	

Default Shell Element in Shell-2000

## Membrane-2000 Response-2000 Triax-2000 Shell-2000

The loading for SE4 is in-plane shear along with moment about the X-axis. Performing a “Solve | Full Response” will take about 30 seconds and produce the following 9-plot picture of the element at failure.

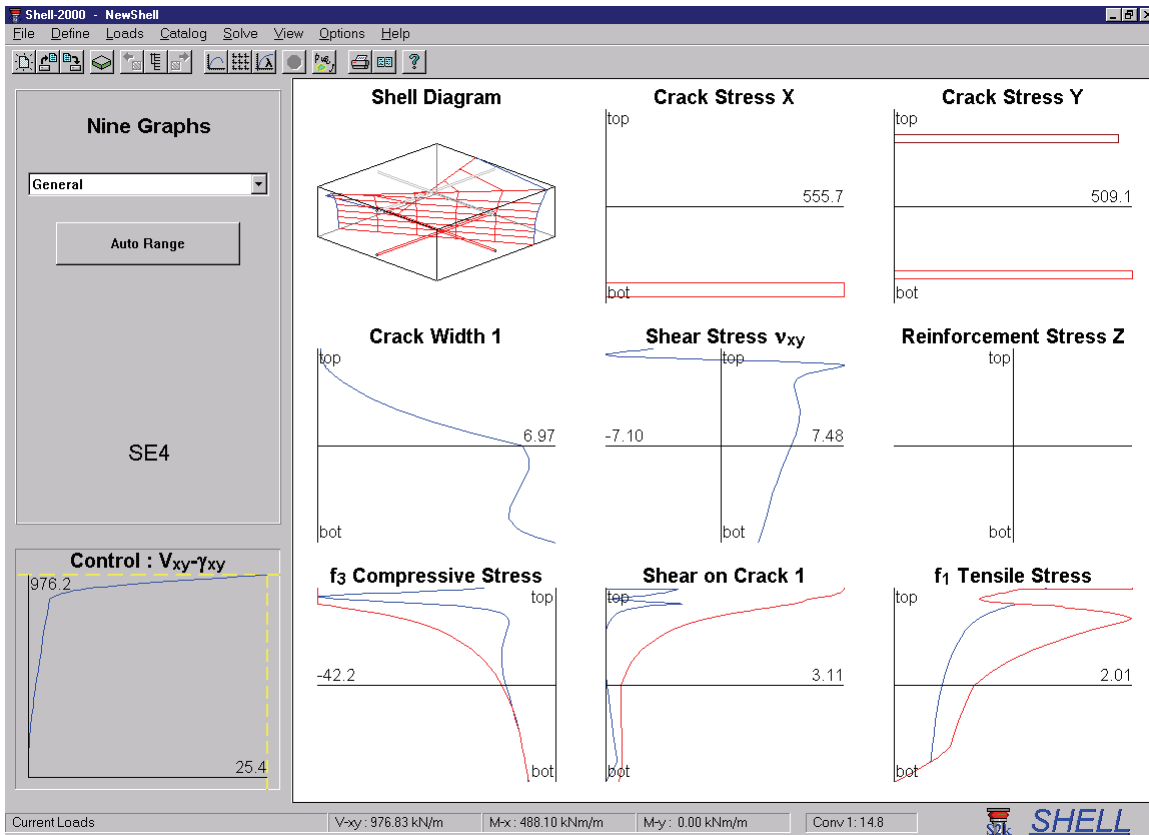

Predicted Failure of Shell Element SE4 by Shell-2000

It can be seen from the control plot that failure is predicted to be fairly ductile. From the bottom line of the program, the failure in-plane shear is predicted to be 976 kN/m. In the test, the element failed in a ductile fashion at an in-plane shear of 961 kN/m. The nine plots show the state of the element at failure. The steel is predicted to be yielding on the top and bottom of the shell in the Y direction as well as in the bottom steel in the X direction. The crack plot shows that the element is predicted to have full-depth cracking, roughly in the X direction at the top (flexural compression side), and rotated through the depth as a result of the in-plane shear stress. This matches the observed element behaviour. From the principal compression plot, the concrete is predicted to be crushing (two lines touching) at the top due to the flexure as well as at the bottom due to the in-plane shear.

## SECTION II: How to make Input Files

The four programs presented in this manual have a high level of commonality. For example, the materials definition page is identical between them. This section of the manual contains a description of how to make input files for the programs. The differences between the different applications are noted where appropriate. It is useful to have read Section I before reading this section to be familiar with the capabilities of the programs.

Response-2000 allows only one cross section to be input at the same time. The other programs all allow more than one with a catalog of elements used to select between them. See section 2-7 for a description of the catalog.

All programs allow the units to be changed at any time during the running of the program using the “Options | Preferences” menu.

### 2-1 Quick Define Wizard

Each program has a “wizard” to assist in the creation of new cross sections. It will often be necessary to make slight changes to resulting section, as the default values in the programs may not match the desired ones. For example, most of the recent shear tests on beams done at the University of Toronto have been done with 10 mm aggregate, but Response-2000 assumes  $\frac{3}{4}$  inch (19 mm) aggregate. As such, it is necessary to manually change that value when predicting University of Toronto tests.

*Membrane-2000 / Shell-2000 / Triax-2000 Wizard.*

As Membrane-2000 and Shell-2000 both analyse shell-type elements, they both use the same quick define box. The top third asks for title, element thickness and concrete strength. The concrete is assumed to have 19 mm aggregate, and use the Popovics / Thorenfeldt / Collins concrete stress-strain relationship as explained below in Table 2-1. Each direction of reinforcement is defined by a total percentage, yield stress and a bar type. The programs assume that there are two layers of steel, with the default clear cover of 40 mm. Note that steel may be selected by a

named title (e.g. #5, 20M, etc. See Table 2-4) or by supplying a cross sectional area by clicking on the “select by area” check box. If a bar type is selected that the program doesn’t recognise, a list of all available types will appear.

## Membrane-2000 Response-2000 Triax-2000 Shell-2000

The quick define wizard for Triax-2000 is similar to the above figure, differing only in the addition of a third direction of reinforcement.

### Response-2000 Wizard

The wizard for Response-2000 is more complex and is explained here in some detail. There are four pages to this wizard. Each is shown and explained below.

The first step is shown to the left. It contains general information as well as material properties.

Assumptions about the concrete are the same as the other programs noted above. Steel is assumed to have an ultimate strength 50% higher than the yield value provided and 10% strain at peak stress. There are two types of prestressed reinforcement available, Low-Relaxation strands and stress-relieved strands.

Page 2 selects concrete cross section information. Base types to select from include rectangles, circles, T-beams, I Beams, general hollow-core shapes, elliptical sections, hollow circular columns, and interlocking spiral columns. For each of these sections, the needed variables will be shown on the right side of the screen. A title line along the bottom defines what the titles mean. (Translating “bt” to “Width at bottom and top extremes”, for example”).

Further down in the list are standard sections including CPCI-I beams, CPCI-box beams, PCI Double-T’s, PCI Single-T’s AASHTO highway girders, and Washington DOT sections. For these standard sections, the right entry fields are used for the following four purposes. First to select a type from the selected category (pressing any key will bring up a list) and second to define a haunch (distance from the top of the

## Membrane-2000 Response-2000 Triax-2000 Shell-2000

precast beam to the bottom of the slab). The third box defines the slab depth and the fourth defines the effective slab width. Note that the slab width should be the effective width for the purposes of analysis, rather than the simple geometric size of the slab.

The types of sections that are available to be chosen are user extendable. See section 5-10 for a description of how to do this.

Page 3 of the quick define box contains the definition for the longitudinal reinforcement (but not prestressing strands). Bars are selected similarly to the other programs either by area or by name. The bars will be placed into layers if there are too many to fit within the width of the cross section. Response-2000 uses bar spacing equal to the bar diameter to produce layers of steel.

For standard sections, such as AASHTO beams, the top half of the box is for steel that will be placed into the slab in two layers. If there is no slab, the steel will be placed in the top of the precast section.

For sections that are based on circular cross sections, the top half shows the outer ring of the reinforcement and the bottom section shows the inner ring of reinforcement. In the case shown, the bars are being defined for a column with interlocking spirals and the top and bottom rings are being defined.

The final page of the quick-define menu asks for shear reinforcing and tendon steel. Stirrups are selected by the pattern as well as bar type and spacing. Patterns include Open stirrups, closed stirrups, single-leg stirrup, t-headed single leg, hoop and interlocking hoops.

Tendons are placed in layers as explained above, except that the spacing is automatically selected as 2 inches (50 mm).

## 2-2 Defining General Information

Following the “Define | Quick Define” option in each program is the “Edit General” selection. This allows selecting information such as the title of the section etc. Shown here is the dialog box from Response-2000.

The Title allows multi-line titles, though only the first line will be printed out. The text style tags described in section 5-1 apply here. These allow the use of superscripts, subscripts and Greek characters in the titles.

Crack spacing in each direction is also defined here. For each direction, the crack spacing may be selected as either a constant number, or by selecting the check box, it may be automatically calculated. It is recommended that the spacing always be automatically calculated as it avoids the user from having to think about it, and also better models real behaviour than a simple constant number.

The equation used for crack spacing at a given depth  $z$  is based on the CEB crack spacing suggestions<sup>5</sup> and given by the following equation:

$$\text{Crack spacing} = 2 c + 0.1 d_b / \rho$$

where  $c$  is diagonal distance to the nearest reinforcement in section from current depth

$d_b$  is the diameter of the nearest bar

$\rho$  is the percentage of steel within a depth of  $z \pm 7.5 d_b$

For cases with no reinforcement, the crack spacing is selected as 5 times the depth of the section.

Response-2000, as shown, also has an option for the moment axis to be selected. This represents the depth in the cross section at which any axial load is applied. The default selection of the centroid of the gross concrete section is generally acceptable, and if there is no axial load, then this option has no effect.

## 2-3 Materials Definition

Each program defines material properties for three different categories of materials: concrete, non-prestressed reinforcement and prestressed reinforcement.

Within each category, more than one type may be defined. As such, there may be 60 MPa concrete for a bridge girder as well as 35 MPa concrete for the slab. There may be 1860 MPa low-relaxation steel for the tendons as well as a 400 MPa steel for the deck reinforcement and 300 MPa steel for the stirrups. All these material types are defined within the same file.

### *Basic Properties Page*

The “Define | Material Properties” option gives access to this multi-page tabbed dialog box.

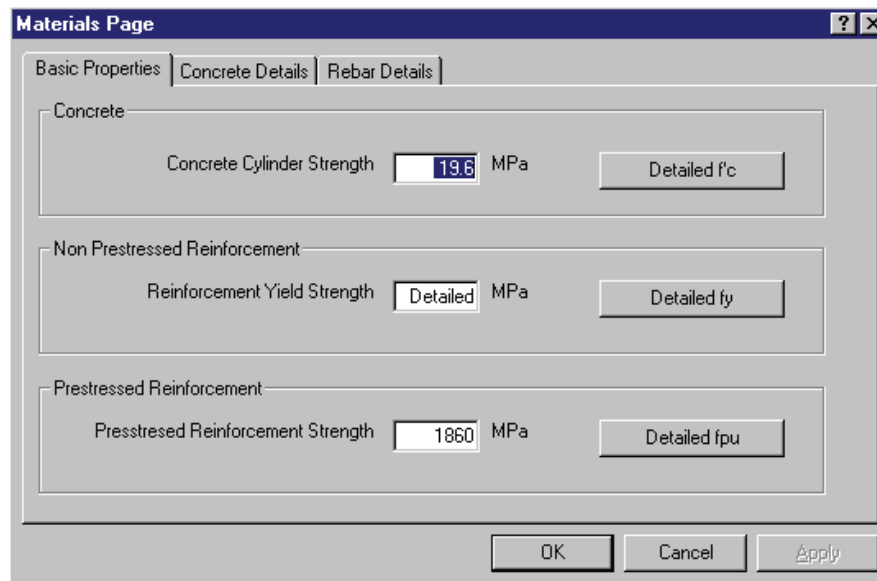

The first page, as shown here, is the general page. If a material type is fully defined by default parameters, such as shown here for the concrete from panel PV20 in Membrane-2000, there will be one number showing as the concrete definition. Clicking on the button to the right labelled “Detailed  $f'_c$ ” will allow altering of these default properties.

If the type has been altered from the default values, or if there is more than one type, then a number won't show up in the general page, rather, it will list “Detailed” as above for PV20 reinforcement where there are different steel definitions for the X and Y directions. To edit the detailed list, click the button beside it. If the detailed title is replaced with a number, the original list of types will be lost after a warning.



*Concrete Detailed Definition*

Response-2000 allows 5 concrete types to be defined, while Membrane-2000, Shell-2000, and Triax-2000 allow only one type. The figure below shows the detailed concrete dialog box page and Table 2-1 defines the variables in it. Each defined type, only one here in the example, is shown with its title in the list on the left. Types may be added or deleted from this list as desired. After making changes to the detailed properties, it is necessary to press the “modify” button on the left to activate the changes before closing the dialog box. New types may be added by filling in the boxes as well as title and pressing “add.” Similarly, unwanted types may be removed with the “delete” button.

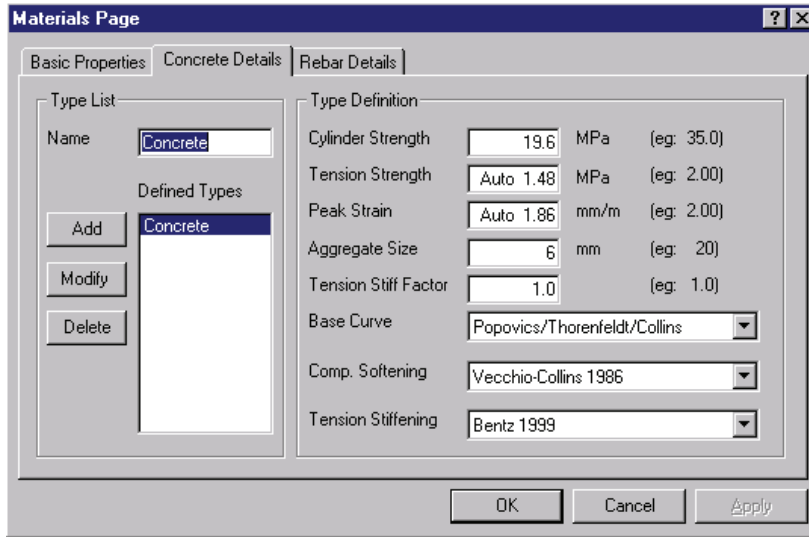

Note that the tension strength and strain at peak stress are prefixed with “auto”. That means that they are estimated directly from the concrete strength and will be automatically updated. If a number is entered into the field, the automatic mode will be turned off.

Table 2-1 Concrete Material Properties, Meanings and Default Values

The listed “default value” is selected automatically when using the “basic properties” page of the dialog box.

Property	Definition	Title	Default Value
Cylinder Strength	Concrete cylinder strength	$f_c'$	40 MPa
Tension Strength	Tensile strength of concrete	$f_t$	$0.45(f_c')^{0.4}$ MPa
Peak Strain	Strain at peak stress This should not be modulus of rupture, but rather a value such as the ACI shear cracking stress this value, $f_c'$ , and base curve define stiffness	$e_0$	As listed in Ref 5 Page 63
Aggregate Size	Maximum Aggregate size Used for shear on crack calculations. Reduced for high strength concrete to model smooth cracks	Maxagg	19 mm (3/4 inch) linearly reduced to 0 mm from 60-80 MPa
Tens. Stiff factor	Relative amount of tension stiffening.	$ts_{factor}$	1.0
Base Curve	<i>Basic shape of concrete base curve:</i>		
	Linear	linear to $(\epsilon_0, f_c')$ , zero after	
	Parabolic	Parabolic through $(\epsilon_0, f_c')$ and $(2\epsilon_0, 0)$	
	Popovics/Thorenfeldt/ Collins	Default equation from Ref (5)	
	Segmental	User defined curve: See Section 5-5	
	Elasto-Plastic	linear to $(\epsilon_0, f_c')$ , constant at $f_c'$ until $2 \times \epsilon_0$	

TABLE 2-1 (Continued)

Compression	<i>Models lowering of concrete strength with increasing transverse tensile strain</i>	
Softening	There are many models here. For normal strength concrete, the Vecchio-Collins 1986 model is suggested. For very high strength concrete (>90 MPa), the Porasz-Collins 1989 model is recommended.	
	None	No change in compressive capacity with tensile strain <i>This option does not model concrete well</i>
	Vecchio-Collins 1982	Equation proposed by Vecchio, Ref 3 <i>This works well for normal and low strength concrete</i>
	<b>Vecchio-Collins 1986</b>	Equation proposed by Vecchio/Collins, Ref 1 <i>This is a simplification of the above equation: Recommended</i>
	Vecchio-Collins 92-A	Equation proposed by Vecchio/Collins, Ref 6 <i>This is a new fit to the data. Comparable to the 1982 eq.</i>
	Vecchio-Collins 92-B	Equation proposed by Vecchio/Collins, Ref 6 <i>This is a new fit to the data. Comparable to the 1986 eq.</i>
	Mehlhorn et al	Equation proposed by Mehlhorn et al, Ref 7 <i>This does not model concrete well for high strains</i>
	Maekawa et al	Equation proposed by Maekawa, et al 8
	Noguchi et al	Equation proposed by Noguchi, et al 9
	Belarbi-Hsu proportional	Rotating Angle Softened Truss Model Relation Ref 10. If this is selected with Tamai tension stiffening, program runs in RA-STM mode.
	CAN CSA S474	Offshore Code. Like V-C '86 but Not a function of $e_0$
	Collins 1978	Compression Field Theory Equation Ref 11.
	Kaufmann-Marti 1998	Equation proposed by Kaufmann and Marti Ref 12 <i>This is fit to many RC panels from Canada/Japan/USA</i>
	<b>Porasz-Collins 1988</b>	Equation proposed by Porasz and Collins Ref 13 <i>Recommended method for very high strength concrete</i>
	Hsu-Zhang 1998	Model of RA-STM 98 and FA-STM98. Ref 14 <i>Concrete crushes early in this model. Not recommended</i>
	Hsu 1993	Another model from the Houston RA-STM. Ref 15
Tension	<i>Models the post cracking tensile strength in reinforced/prestressed concrete</i>	
Stiffening	The Bentz-1999 model is suggested.	
	None	Ignore post cracking tension stiffening
	Vecchio-Collins 1982	Equation proposed by Vecchio Ref 3
	Collins-Mitchell 1987	Equation proposed in 1987 textbook Ref 16 <i>Suggested Equation if Bentz 1999 method not used</i>
	Izumo et al	Equation proposed by Izumo et al 17
	Tamai et al	Tamai, also used by Hsu models 18
	Elasto-Plastic	Full cracking stress at any strain after cracking
	<b>Bentz 1999</b>	Tension stiffening based on strain and distance to steel <i>See Reference 2 to find out how this works</i>

Reinforcement Detailed Definition

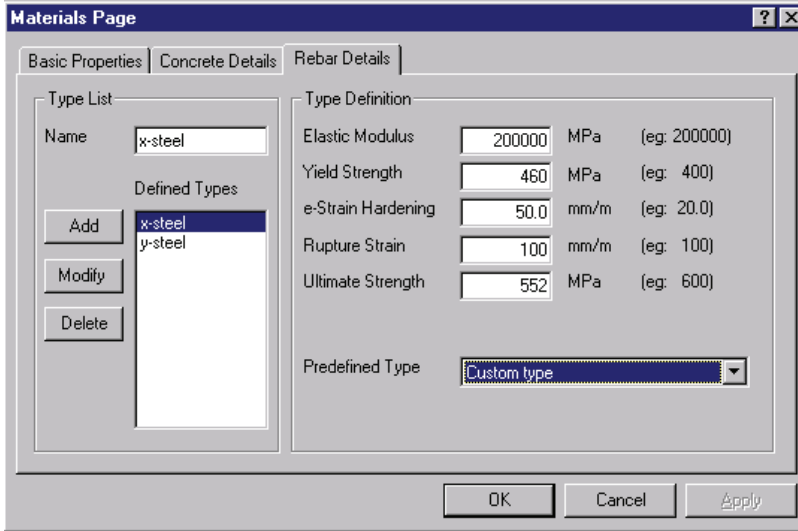

Non-prestressed steel is defined in a similar manner to that above for concrete. Note that the example shown has 2 different types of steel defined. The values currently shown at the right are for the selected “x-steel” type. Clicking on the “y-steel” type would allow that to be edited as well.

The “predefined type” option allows selection from common types of steel defined in Table 2-2, below, along with all the other parameters used in this dialog box.

Table 2-2 Reinforcement Material Properties Meanings and Default Values

Property	Definition	Title	Default Value
Elastic Modulus	Stiffness before yield	E	200,000 MPa
Yield Strength	Proportional limit	$f_y$	400 MPa
e-strain harden	Strain at strain harden	$\epsilon_{sh}$	7 mm/m
Rupture strain	Strain at Ultimate stress.	$\epsilon_u$	10%
Ultimate strength	Maximum stress	$f_u$	1.5 x $f_y$

Curve is linear to yield, flat post yield, and quadratic after strain hardening. Slope is zero at location of maximum stress and strain.

*Predefined Options*

	E (MPa)	$f_y$ (MPa)	$\epsilon_{sh}$ (mm/m)	$\epsilon_u$ (mm/m)	$f_u$ (MPa)
ASTM A615 40 ksi	200000	276	20.0	120.0	483
ASTM A615 60 ksi	200000	414	15.0	80.0	621
ASTM A706 60 ksi	200000	414	15.0	120.0	552
CSA G30.12 300 MPa	200000	300	20.0	110.0	450
CSA G30.12 400 MPa	200000	400	15.0	80.0	600
CSA G30 400 Weld	200000	400	15.0	130.0	550
1030 MPa Dywidag	200000	800	10.0	40.0	1030
1080 MPa Dywidag	200000	820	10.0	40.0	1080

*Prestressing Steel Detailed Definition*

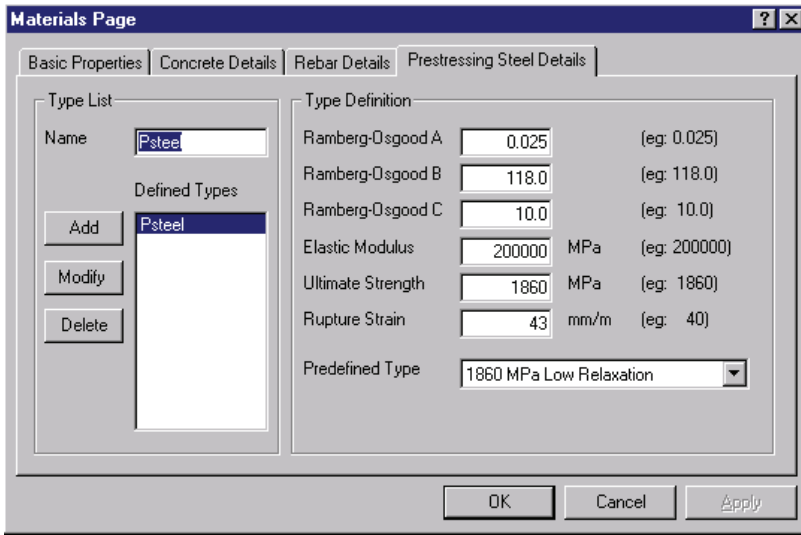

Steel to be used for tendons is defined using the Ramberg-Osgood formulation as explained in Reference 5.

Generally, it will be acceptable to simply select one of the two predefined types. If more information is available about the stress-strain properties, however, Ref. 5 provides a method to calculate the parameters A, B and C as

listed in the dialog box.

*Table 2-3 Prestressed Reinforcement Material Properties, Meanings and Default Values*

Property	Definition	Title	Default Value
Ramberg-Osgood A	the A parameter of the model	A	0.025
Ramberg-Osgood B	the B parameter of the model	B	118.0
Ramberg-Osgood C	the C parameter of the model	C	10.0
Elastic Modulus	Stiffness before yield	E	200,000 MPa
Ultimate strength	Maximum stress	$f_u$	1860 MPa
Rupture strain	Strain at bare-strand rupture	$\epsilon_u$	43 mm/m

*Predefined Options*

	A	B	C	E (MPa)	$f_u$ (MPa)	$\epsilon_u$ (mm/m)
1860 MPa Low-Relax	0.025	118.0	10.0	200000	1860	43
1860 MPa Stress-Relieved	0.030	121.0	6.0	200000	1860	43

## 2-4 Concrete Cross Section

The “Define | Concrete Cross Section” menu option defines the area of concrete to use in the analysis. Response-2000 requires a beam or column cross section. Shell-2000 and Membrane-2000 simply require one number: the shell thickness and Triax-2000 requires no dimensions at all. Only Response-2000 will be explained in this section.

### *Response-2000 Concrete Cross Section Definition*

The Response-2000 concrete definition menu option uses a three page tabbed dialog box. The first page is for general shapes such as squares and circles, the second page is for standard sections, and the final page is for general sections of any complexity.

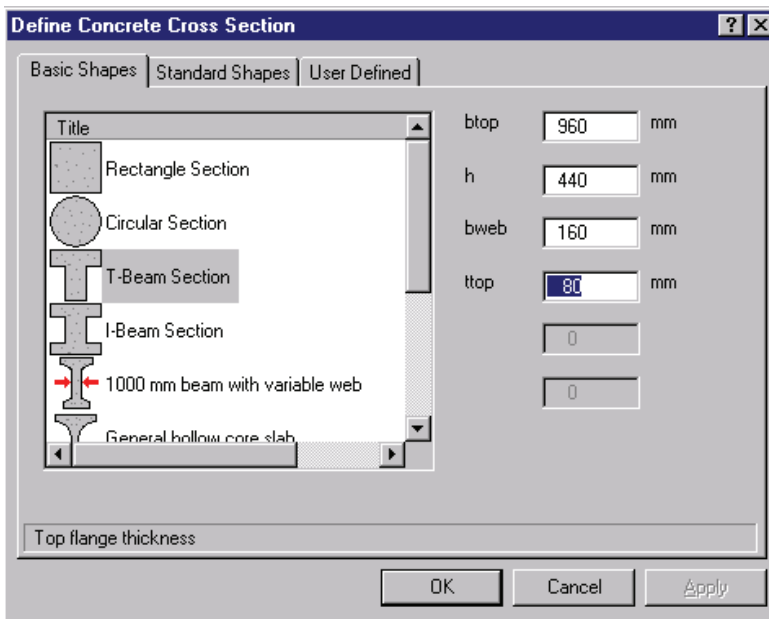

Page one is similar to the quick-define selection explained above. Each basic type has a different number of variables to be entered and these are shown to the right. In the example, the top flange thickness is being entered, and a title explaining the name is shown at the bottom of the window.

See section 5-9 to find out how to add more sections to this listing.

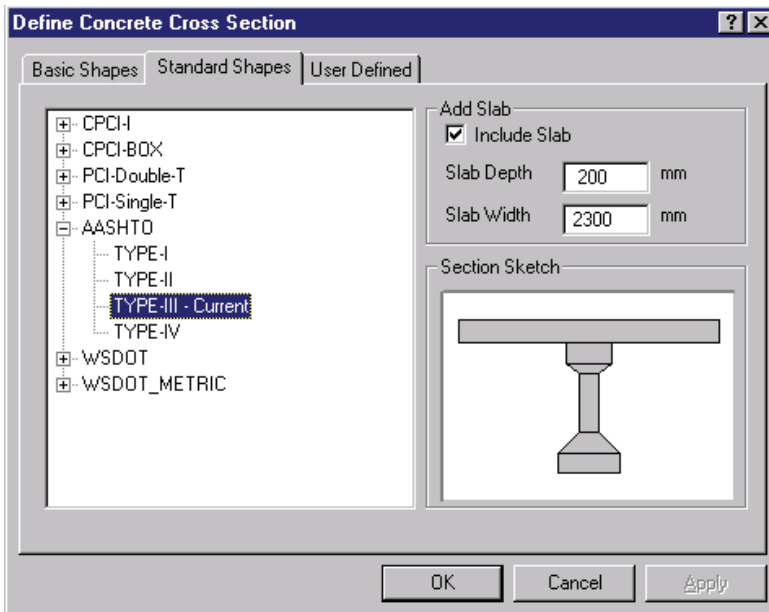

Page two shows each standard type in a list along with the ability to automatically add a slab if the checkbox on the top right is selected. Shown is the built-in AASHTO style girders with a Type III selected with a slab on top.

See Section 5-10 to find out how to add more standard sections to this listing.

Page three of the concrete box in Response-2000 allows any concrete geometry at all to be defined as well as definition of concrete type regions. Sections entered in page one or two may be “tuned” using page three.

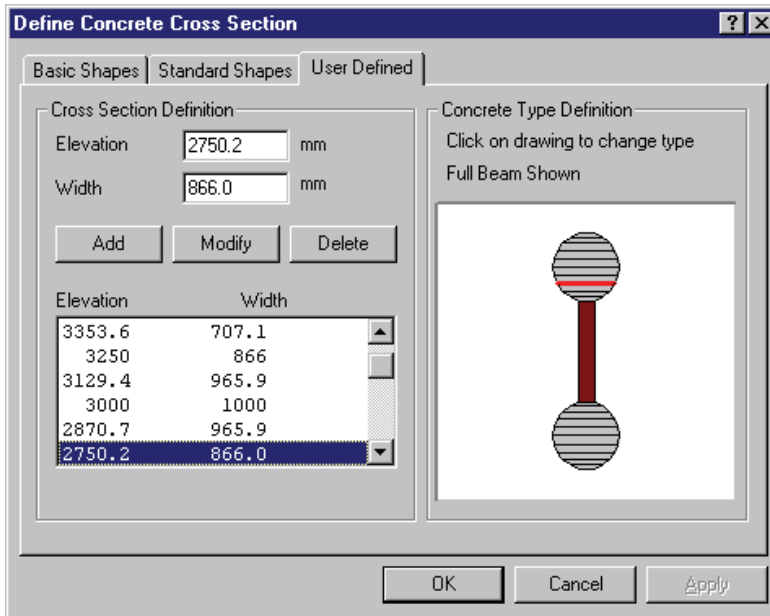

The left side of the page deals with the geometry itself. The right side shows a scale drawing of the definition and colours the sections differently depending on the type.

The definition is made up of a series of height-width pairs as shown in the list-box on the left. The zero location for the y-axis is chosen to be at the bottom of the cross section, but distances may be

entered at any depth. (I.e. entering negative depths is acceptable). If there is a sudden change in section width, for example at the bottom of a slab, two lines in the list have the same depth. The one higher in the list refers upwards and the lower one in the list refers downwards. In the event that Response-2000 cannot tell if a new point should refer upwards or downwards, the user is shown both options and asked to select which is correct.

The Add/Modify/Delete buttons act in the expected way, adding a line to the listing, modifying an existing line or removing a line from the listing. Note that the selected line in the listing is shown in red on the sketch on the right side.

To enter a elliptical section, enter the width at the bottom and top extremes, say, 200 mm wide 100 mm up and 0 mm wide at 0 mm up as shown in the top right drawing. Adding in a new line with an elevation between the other two, say 50 mm, and a width of “DOWN” (no quotes) will produce the drawing in the second figure. Selecting a width of “UP” instead will produce what’s shown in the third figure. Using combinations of these, circles and ellipses may be easily produced. The “up” or “down” title indicates whether the top or bottom has a zero slope.

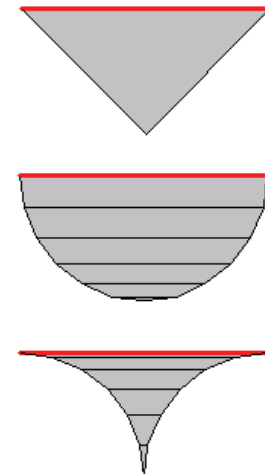

To select concrete material types, click on the sketch on the right side of the dialog box and select the concrete type from the given listing. In the example above, the web is a different type.

## 2-5 Longitudinal Reinforcement

Defining longitudinal steel for Membrane-2000 is identical to Shell-2000 and both are similar to Response-2000 and so all will be explained together.

Steel in the programs is defined either as individual layers of bars or in collections of patterned layers. Patterns include distributed patterns as well as circular patterns. Membrane-2000 and Shell-2000 don't allow circular patterns.

Each dialog box uses the traditional list of layers with the ability to add a new definition, modify an existing one or delete it. This is the same style used in the materials definition page.

### *Individual Layers*

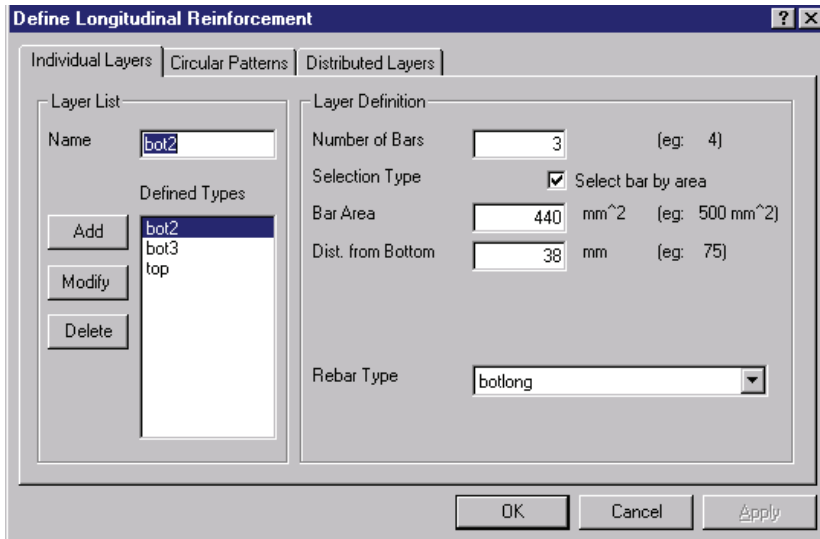

Shown is the Response-2000 longitudinal reinforcement definition page. Membrane-2000 and Shell-2000 are similar except that they ask for spacing of bars rather than the number of bars as well as asking for a prestrain for the bar.

In the example, three layers are defined,

with the one called “bot2” currently highlighted. It has 3 bars defined each with a cross sectional area of 440 mm<sup>2</sup> and a centroid 38 mm above the bottom of the cross section. The type of steel selected is “botlong” which would have been defined in the materials dialog page. Different layers can, of course, use different material types.

Table 2-4 shows the bar types built into the programs. See section 5-8 for a description of how to add new bar types to this listing.



Table 2-4 Reinforcing Bar and Strand Designations

**CSA Reinforcing Bars.**

Bar Designation	Nominal (mm)	Cross Sectional Area (mm <sup>2</sup> )
10M	11.3	100
15M	16.0	200
20M	19.5	300
25M	25.2	500
30M	29.9	700
35M	35.7	1000
45M	43.7	1500
55M	56.4	2500

**CSA Prestressing Strands**

Strand Designation	Nominal Diameter (mm)	Cross Sectional Area (mm <sup>2</sup> )
S9	9.53	55
S11	11.13	74
S13	12.70	99
S13FAT	13.9	107.7
S13S	13.9	107.7
S15	15.24	140

**CSA Reinforcing Alternate Titles.**

Bar Designation	Nominal Diameter (mm)	Cross Sectional Area (mm <sup>2</sup> )
10	11.3	100
15	16.0	200
20	19.5	300
25	25.2	500
30	29.9	700
35	35.7	1000
45	43.7	1500
55	56.4	2500

**US Prestressing Strands (270 ksi)**

Strand Designation	Nominal Diameter (mm)	Cross Sectional Area (mm <sup>2</sup> )
S.25	0.250	0.036
S.375	0.375	0.085
S.5	0.500	0.153
S.5FAT	0.550	0.167
S.5S	0.550	0.167
S.6	0.600	0.215

**Standard US bars**

Bar Designation	Nominal Diameter (in)	Cross Sectional Area (in <sup>2</sup> )
#2	0.248	0.050
#3	0.375	0.110
#4	0.500	0.200
#5	0.625	0.310
#6	0.750	0.440
#7	0.875	0.600
#8	1.000	0.790
#9	1.128	1.000
#10	1.270	1.270
#11	1.410	1.560
#14	1.693	2.250
#18	2.257	4.000

**Deformed Prestressing Bars (Dywidag)**

Bar Designation	Nominal Diameter (mm)	Cross Sectional Area (mm <sup>2</sup> )
PB15	15.0	177
PB26	26.5	551
PB32	32.0	804
PB36	36.0	1018

Table 2-4 Reinforcing Bar and Strand Designations (con't)

**US Proposed Metric Titles**

Bar Designation	Nominal Diameter (mm)	Cross Sectional Area (mm <sup>2</sup> )
M10	9.5	71
M13	12.7	129
M16	15.9	200
M19	19.1	284
M22	22.2	387
M25	25.4	510
M29	28.7	645
M32	32.3	819
M36	35.8	1006
M43	43.0	1452
M57	57.3	2581

**Bars nominal by diameter**

Bar Designation	Nominal Diameter (mm)	Cross Sectional Area (mm <sup>2</sup> )
1 mm	1	0.785
2 mm	2	3.142
3 mm	3	7.069
4 mm	4	12.57
5 mm	5	19.63
6 mm	6	28.27
7 mm	7	38.48
8 mm	8	50.27
9 mm	9	63.62
10 mm	10	78.54
11 mm	11	95.03
12 mm	12	113.1
13 mm	13	132.7
14 mm	14	153.9
15 mm	15	176.7
16 mm	16	201.1
17 mm	17	227.0
18 mm	18	254.5
19 mm	19	283.5
20 mm	20	314.2
21 mm	21	346.4
22 mm	22	380.1
23 mm	23	415.5
24 mm	24	452.4
25 mm	25	490.9
26 mm	26	530.9
27 mm	27	572.6
28 mm	28	615.8
29 mm	29	660.5
30 mm	30	706.9
31 mm	31	754.8
32 mm	32	804.2
33 mm	33	855.3
34 mm	34	907.9
35 mm	35	962.1
36 mm	36	1018

**Japanese Bars**

Bar Designation	Nominal Diameter (cm)	Cross Sectional Area (cm <sup>2</sup> )
JD6	0.64	0.32
JD8	0.80	0.5
JD10	0.95	0.71
JD13	1.27	1.27
JD16	1.59	1.99
JD19	1.91	2.87
JD22	2.23	3.87
JD25	2.55	5.07
JD29	2.86	6.42
JD32	3.18	7.94
JD35	3.50	9.57
JD38	3.82	11.4
JD41	4.14	13.4

*Distributed Layers Pattern*

Pattern layers allow easy definition of reinforcing. The pattern lists have an additional button as well that allows the pattern to be “exploded” into individual layers.

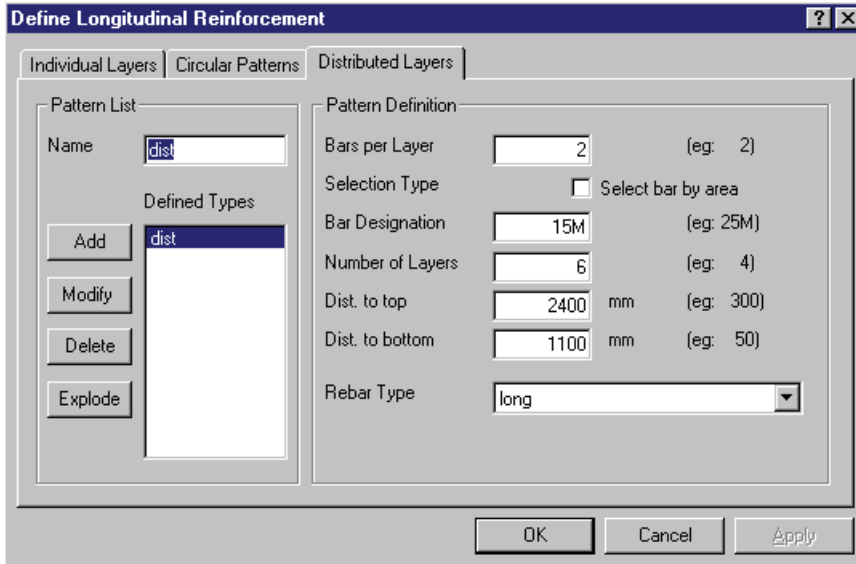

The shown “Distributed Layers” allows a series of individual layers to be automatically repeated. The example shows part of a wall with 15M bars at each face spaced at 300 mm. Two bars per layer for 6 layers are used to define this.

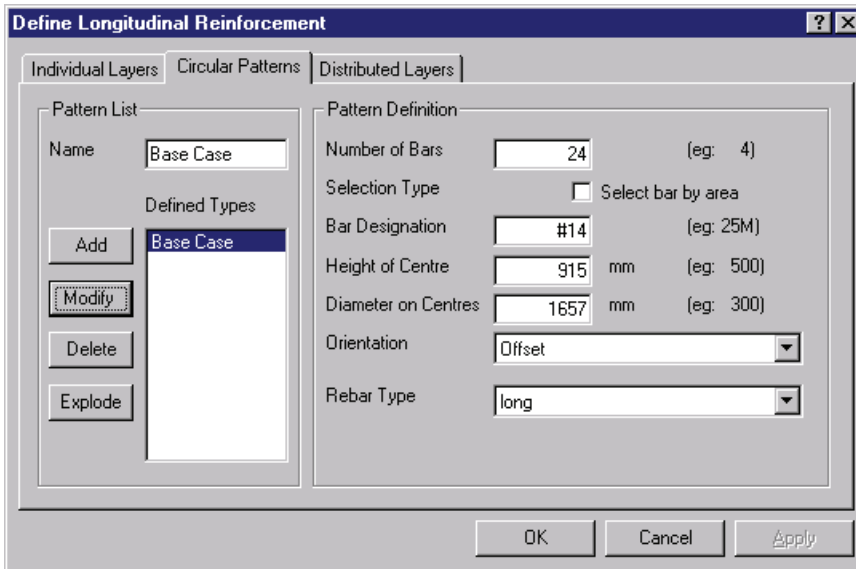

Circular patterns, only available in Response-2000, allow reinforcement to be easily added for round columns. This example shows a large column with 24 #14 bars at the listed geometry. The Orientation specifies the angular offset of the pattern. If the selection is “aligned”, then there

will be a bar at the 12-o’clock position on the drawing. If the setting is “offset”, as here, the top 2 bars are balanced around the 12-o’clock position. With more than perhaps 6 bars, this has very little impact, but can be important if there are only, say, 4 bars in the pattern.

*Tendon Layers*

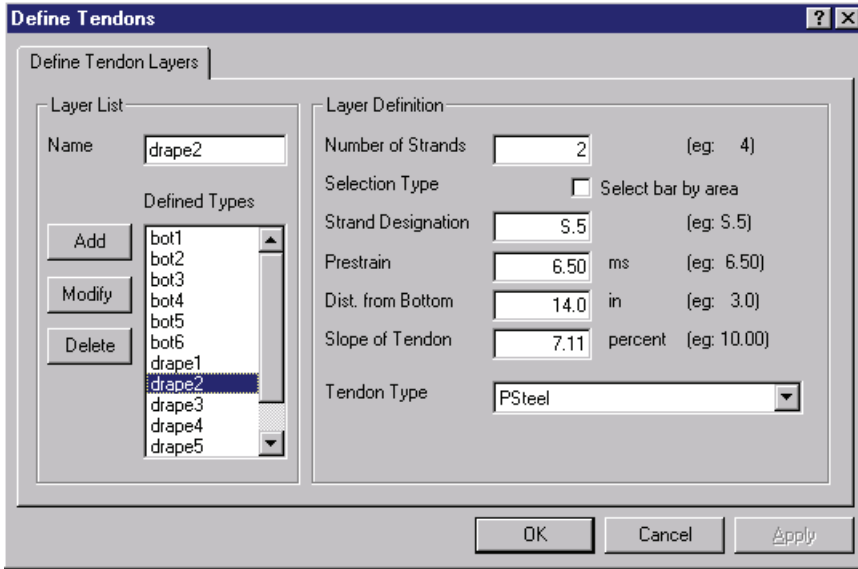

Response-2000 allows explicit definition of tendon layers as opposed to longitudinal reinforcement layers. The example shows a long list of individual layers for tendons. Each is defined as the number of strands, prestrain, distance from bottom of section, type and drape. Drape is

defined as the rise over run of the strands. As such, the shown example would rise in 20 feet a distance of  $0.0711 \times 20 = 1.422$  feet rise per 20 feet of run.

Membrane-2000 and Shell-2000 allow prestressed steel from the normal layer dialog box. Draped strands are not supported for shell elements and membranes.

*Triax-2000*

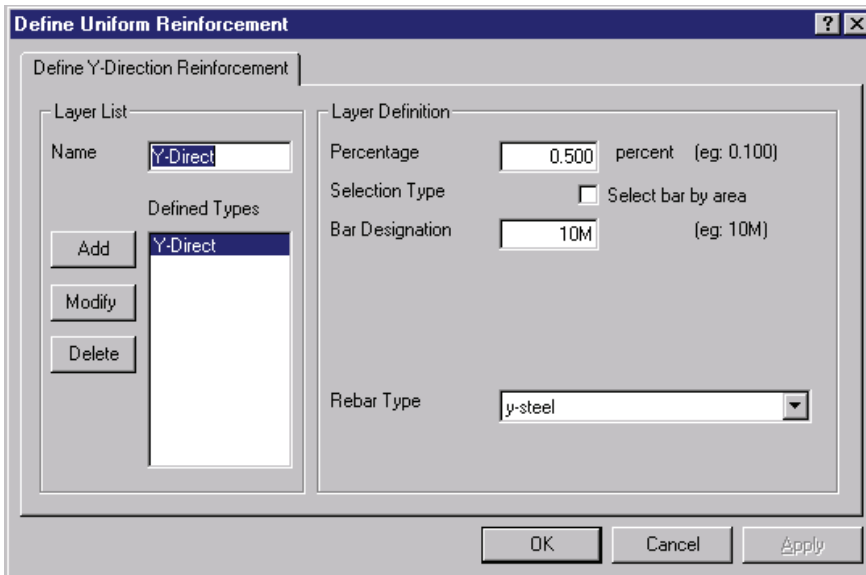

Triax-2000 reinforcement, in each direction X, Y, or Z, is defined more simply than the other programs as there is very limited spacing information that needs to be defined. It is simply defined by the percentage of steel and the bar type.

## 2-6 Transverse Reinforcement

Transverse reinforcement, like longitudinal reinforcement, is defined similarly between Shell-2000, Response-2000 and Membrane-2000. Note that Triax-2000 doesn't have any definition for transverse reinforcement as in a 3D block of concrete, the transverse direction is actually the longitudinal Z direction.

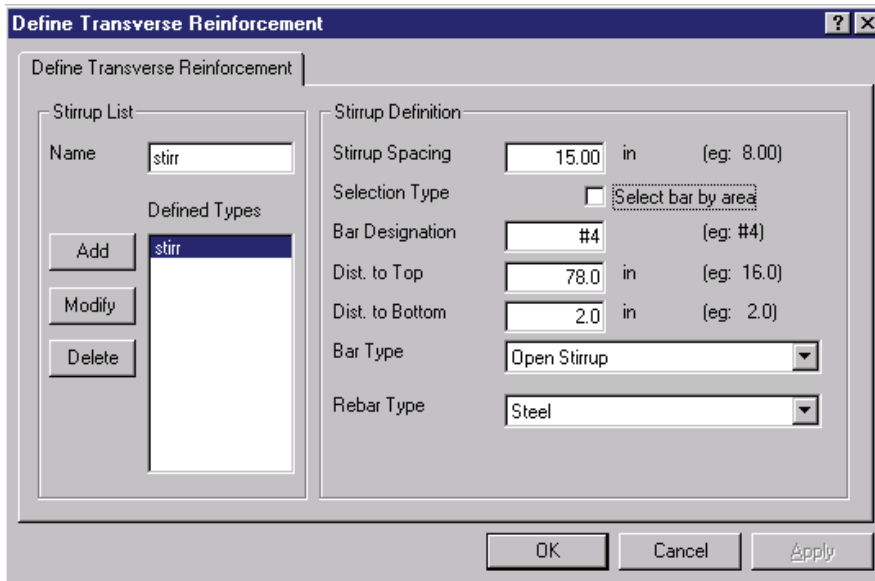

The example shows the dialog box from Response-2000. Stirrups are defined by spacing, bar type, material type and geometry. The geometry is defined in terms of the top and bottom ends of the reinforcement as well as the type of bar. Response-2000 allows stirrups to be:

Closed Stirrups, Open Stirrups, Hoops, Single-Leg hooked bars or Single-Leg T-Headed bars. Each kind of bar is assumed to be able to yield all the way to the end of the bar as entered (i.e. no development length). This is reasonable if there is a t-head or a hook at the end of the bar but means that a correction should be made for transverse bars that are not properly anchored.

Membrane-2000 and Shell-2000 use a similar dialog box with the following differences. The spacing term is replaced by a transverse percentage. The stirrup types are limited to single-leg hooked bars and single leg t-headed bars. Note that the single-leg hooked bars are currently drawn on the screen as t-heads.

## 2-7 Element Catalog

While Response-2000 only allows one cross section per input file, the other programs all allow more than one by use of the catalog menu option.

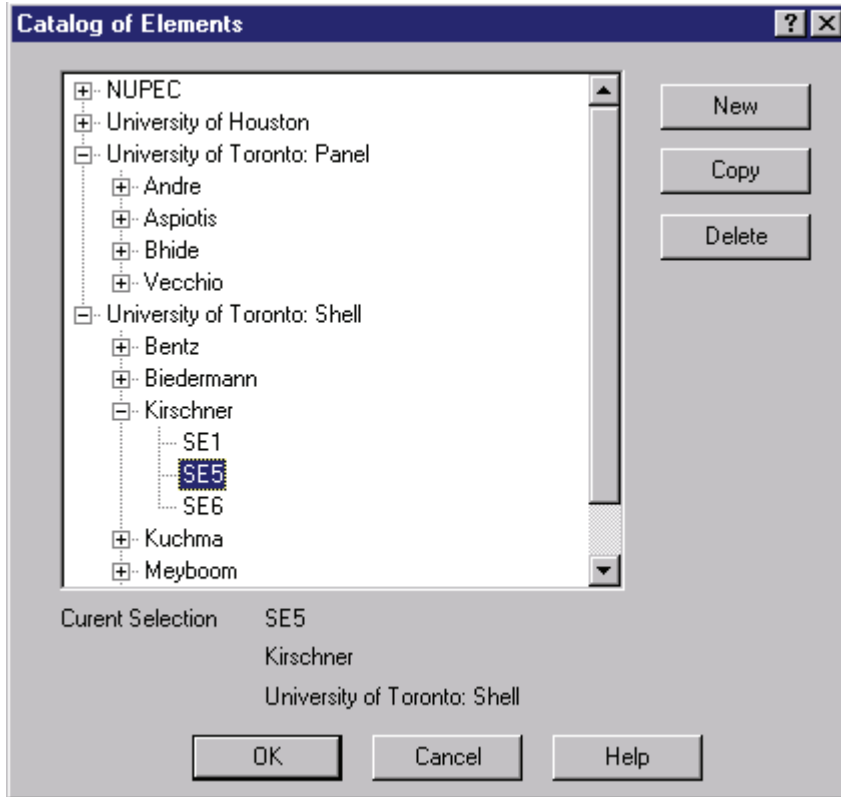

The example here shows the catalog in use with Membrane-2000 showing a list of experimental tests. Shell element SE5 is currently selected from the listing. The catalog is based on the familiar Windows Explorer tree-system. The different titles used are from the “Edit General” page in the define menu.

The catalog buttons on the right allow a new element to be created using the Quick Define Wizard, copying of an existing element, or deleting of

an element from the catalog.

When using the programs, it is possible to switch to a different element via either the catalog itself, the menu options “Catalog | Next Element”, “Catalog | Previous Element”, or using the toolbar.

This fragment of the toolbar, shown here from Membrane-2000 allows access to the catalog itself from the button that looks like a little tree-list between the arrows. The arrow pointing left goes to the previous element in the listing, and the arrow to the right goes to the next element in the list. In this way it is easy to examine many elements from within one file.



## SECTION III: Loading and Analysis Options

This section defines the options in the “loads” menu option of each of the programs. As there are important differences between the four programs in this regard, they will be explained here individually. As Response-2000 is the most complex, it is explained last.

### 3-1 Membrane-2000

#### *Loading*

	Constant	+	Increment	
Axial - X	0.00	+	0.00	MPa
Axial - Y	0.00	+	0.00	MPa
Shear	0.00	+	1.00	MPa

For a single load level, only use the "constant" values

OK Cancel Help

Loading for Membrane-2000 consists of Axial stress in the X direction, Axial stress in the Y direction, and in-plane shear. Positive axial stresses indicate tension with negative indicating compression. The shear must be non-zero and positive in Membrane-2000.

The left column defines the stress level to start the analysis at, as well as defining the load combinations to use for the “one load” solution. The right side holds the loading ratios for any increment

in load beyond the initial level. Note that it is the ratios that matter, not the magnitude of the numbers themselves. The example shown represents an analysis for pure shear starting with no load on the panel.

#### *Shrinkage and Thermal Strains*

Membrane-2000 allows the concrete to have a selected shrinkage using the “Loads | Shrinkage and Thermal Strains” menu option. Note that any thermal strains in the reinforcement may be applied as reinforcement prestrains. Enter negative strains in the shrinkage dialog box to indicate that the concrete has shrunk.

#### *Experimental Results*

Because Membrane-2000 represents the type of element tested to define the MCFT, a facility has been included to allow experimental results to be shown. This is demonstrated in Section I, Quick Start for Membrane-2000 where the results from panel PV20 tested by Vecchio are shown.

The experimental results are added one variable at a time. A dialog box allows access to 12 variables. Experimental data in the form of a column of numbers may be entered by hand or using the “paste” button on the page. There must be the same number of data points for each variable and they must be in the same order. When an analysis is

Membrane-2000 Response-2000 Triax-2000 Shell-2000

run, Membrane-2000 checks if data has been entered for both the X and Y axes of the plots. If so, it includes the experimental data along with the calculated solution.

The last menu option in the loads menu of Membrane-2000 allows the data to be quickly removed from, for example, the default input example.

### 3-2 Triax-2000

#### Loading

As an analysis program of a general 3D solid, Triax-2000 requires 6 loads to be defined to perform an analysis. These are Axial force in the X, Y, and Z direction plus shear on the X-Y, Y-Z, and X-Z planes.

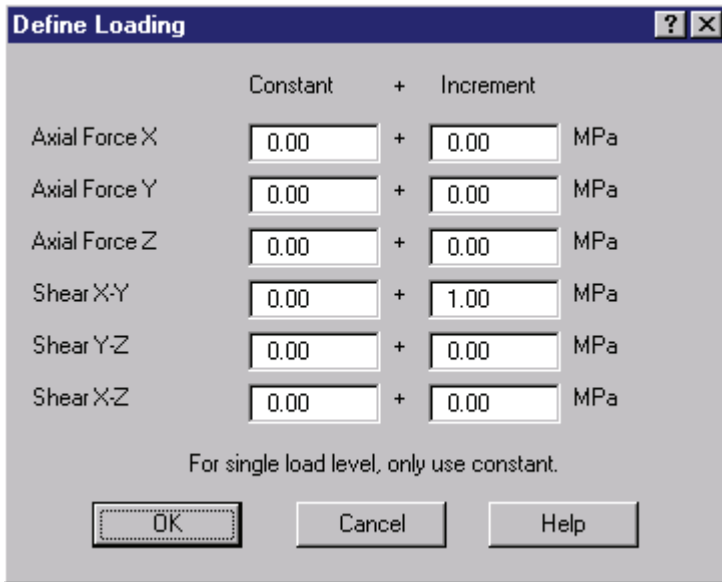

Positive axial stresses indicate tension with negative indicating compression. Positive shear stresses have the shear arrows pointed in the positive axis directions. The signs of the shears and axial stresses may be positive or negative.

As with the other programs, the first column is for the initial loading or single load level analysis. The second

column is used for ratios between the loads for a full response type of analysis.

#### Shrinkage and Thermal Strains

Shrinkage can be set via the “loads | shrinkage and thermal strains” menu choice. Shrinkage is assumed to be constant for the volume of materials. A negative strain indicates that the concrete has shrunk.



### 3-3 Shell-2000

#### Loading

Shell-2000 allows all 8 force resultants on a shell element to be applied. The loads are applied in force resultant per unit length. For example, moments are in kNm/m or kip.ft/ft and axial forces are in kN/m or kips/ft. The applied loads are:

Component	Sign
Axial force in X and Y	(tension positive)
Moment in X and Y	(compression on top positive)
Shear on X-Z and Y-Z planes	(shear arrow up is positive)
In-Plane Shear	(shear arrows in positive axis directions)
Twisting Moment	(positive = Positive in-plane shear on bottom Negative in-plane shear on top of shell)

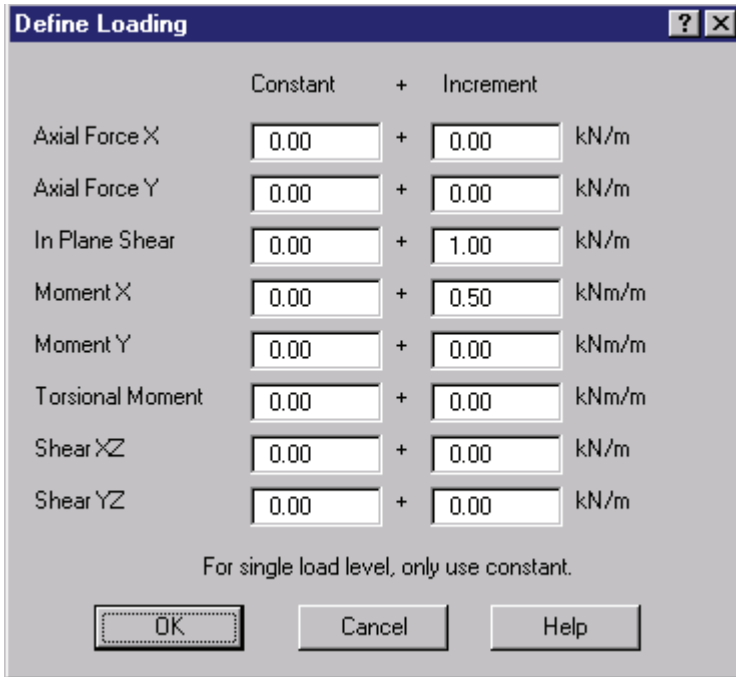

Like the other programs, the loading is defined in terms of a constant load for initial load level and an increment. The magnitudes of the increments are not important; only the ratios and signs are used by Shell-2000.

In this example, the element is subjected to an in-plane shear stress as well as a moment with the ratio of moment to shear equal to 500 mm.

#### Shrinkage and Thermal Strains

Like Triax-2000, shrinkage may be applied as a constant value for the whole element. Thermal strains in the reinforcement may be applied by the use of prestrains. A negative value in the shrinkage dialog box means that the concrete has shrunk.

### 3-5 Response-2000

#### Loading

Response-2000 allows axial load, moment and shear to be applied to the element. Positive axial force is tension and negative axial force is compression. Positive moment indicates compression on the top of the section. The shear term must be positive.

Like all the programs, loading is provided on the left side for a starting load level or a single load analysis, and on the right for the increments in load. The actual magnitudes of the incremental values are not important. Response-2000 only uses the signs and values relative to each other.

For this example, there is no initial load level, and the moment to shear ratio is 1.34 feet.

#### Time Dependent Effects

To assist in the examination of time-dependent effects, Response-2000 includes a routine that implements the AASHTO-94<sup>19</sup> suggested methods for shrinkage, creep and prestressing strand relaxation. This is accessed via the “Loads | Time Dependent Effects” menu option. Note that it does not model the increase in concrete strength with time, as that is too dependent on individual mix designs.

This module will only be used if the checkbox at the top is selected. The age for long-term behaviour is needed, as is the sustained moment for the section as that strongly affects the creep.

Briefly, the shrinkage and relaxation is estimated for the given age and the creep under the given sustained moment is estimated. Then a shrinkage/thermal profile is automatically added to the section to model this. Analyses done then represent short term loading on a well-aged beam or column. For a more detailed description of the time-dependent effects module, see Reference 2.

*Detailed Shrinkage and Thermal Strains*

To account for structures such as large box-girders where there is a substantial thermal gradient over the depth of the structure, Response-2000 allows this to be selected with some detail.

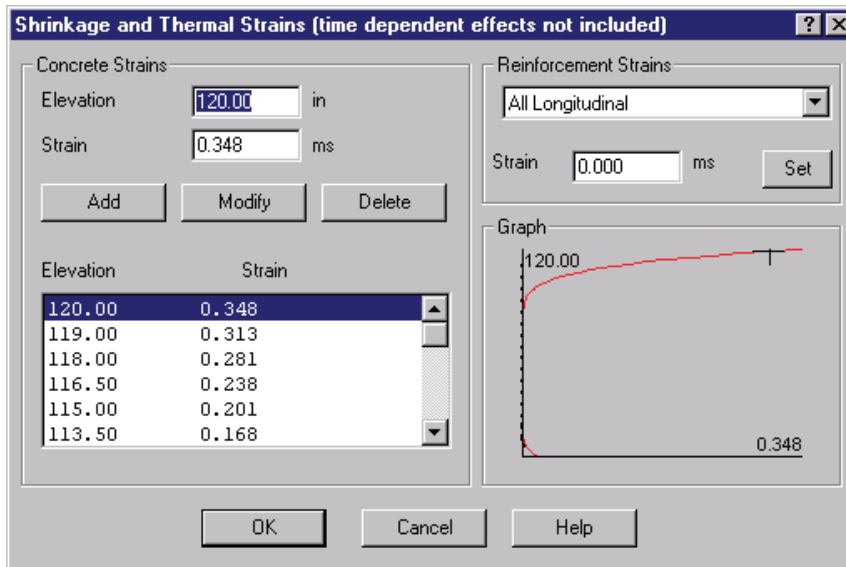

Note that the shrinkage and thermal strains calculated above in the time-dependent effects are not reflected here.

The left side of the dialog box allows selection of values of shrinkage at selected depths. Response-2000 parabolically interpolates between these points.

The top right side allows setting of individual thermal strains for the reinforcement. As shown, it is also possible to select a value and apply it to all layers of reinforcement. Note that these strains can be used the same way as prestrains are to tendons if desired.

The bottom right shows a plot with a line indicating the shrinkage distribution and with little dots to indicate the thermal strains of the reinforcement.

The example shows a 120 inch high section with a large distribution of thermal strains in the top as well as a small distribution in the bottom. The reinforcement does not have any thermal strains defined for it.

## Membrane-2000 Response-2000 Triax-2000 Shell-2000

*Strain Discontinuity*

The strain discontinuity dialog box allows modelling of behaviour effects due to composite construction. See section 5-7 for a description and example of how best to use the strain discontinuity feature. In general, it allows for an explicit difference between the longitudinal strain profile at a given depth and the basic assumption that plane sections remain plane.

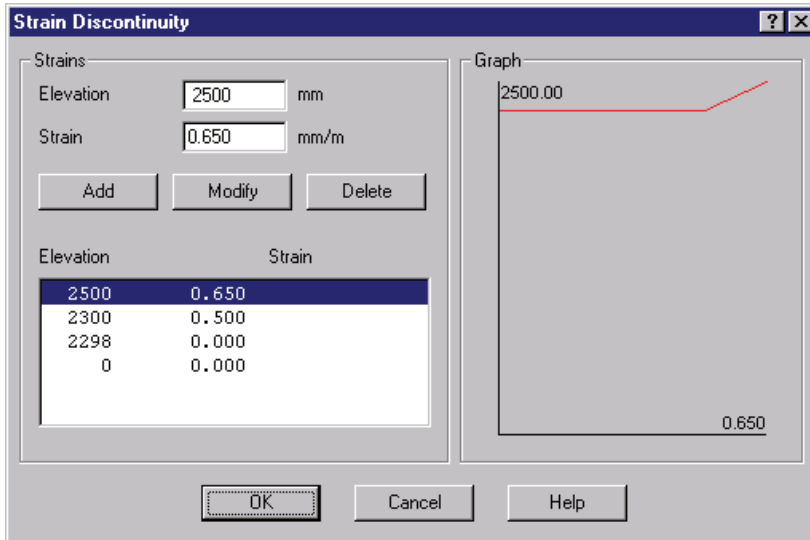

The interface is similar to the shrinkage page above. Elevation-strain pairs are added to the list and they are plotted on the graph at the right.

In this example, a 2300 mm precast section was given a 200 mm slab on top and the strain discontinuity models the difference from plane-sections for

this slab.

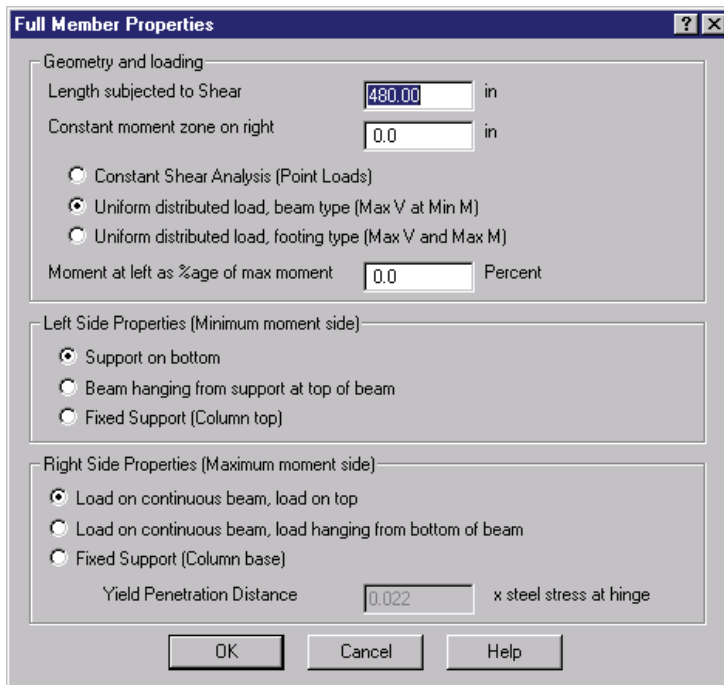
*Full Member Properties*

A full member analysis will calculate force deflection relationships for simple beams. The beam must be prismatic with the load applied at the right end and a support at the left end. Response-2000 requires the length subjected to shear, the length with no shear at midspan (for beams loaded with 2 point loads), the type of loading (point load, UDL beam type or UDL footing type), and the moment at the left end relative to the right end. For a beam type analysis, the left end moment is often equal to zero, as this is where the support would be.

The left side support may be selected as a support on the bottom of the beam, a hanging support from the top of the beam, or a fixed support. In addition to changing how the beam is drawn, the left support changes the assumed load sharing between strut action and sectional action in the analysis.

The right side has similar options. In this case, the fixed support also needs information about the penetration of strains into the bottom block of concrete that would be supporting the column. The default value of 0.022 is suggested for columns. See Reference 2 for an explanation of how this is used.

## SECTION IV: Analysis and Interpretation

### 4-1 General Information

All programs in this manual operate in a similar way. The results of the analysis are dynamically updated on the screen as the user changes the load level. Using this method of fast information presentation, it becomes possible to quickly see what is predicted to be happening to the concrete and find errors. It has been found that this not only increases confidence in the results, but also adds to the users understanding of the behaviour of reinforced concrete. The presentation of the results also challenges the user to explain any strange or unexpected result. This too enhances the users understanding of reinforced concrete. This contrasts with some computer programs for structural analysis that attempt to remove the engineer from the process resulting in less understanding from the use of the program rather than more.

Membrane-2000 and Triax-2000 perform their analysis immediately and let the user observe the results. Response-2000 and Shell-2000, due to longer execution times, update the screen as new results are obtained and let the user watch the results as they arrive. The different screens of data presentation are available from the "view" menu in the programs or, more conveniently, through the toolbar.

The default data presentation mode in the programs is a screen with 9 graphs on it. This manual will concentrate on that "9-plot" view. The program also has a mode to allow the same plots to be shown individually. For Triax-2000 and Membrane-2000, the plots in the 9-plot mode are generally full load-deformation plots. For Response-2000 and Shell-2000, the plots represent one load stage showing the value of the variable over the depth of the element. An additional page is available that provide load-deformation plots for the latter programs.

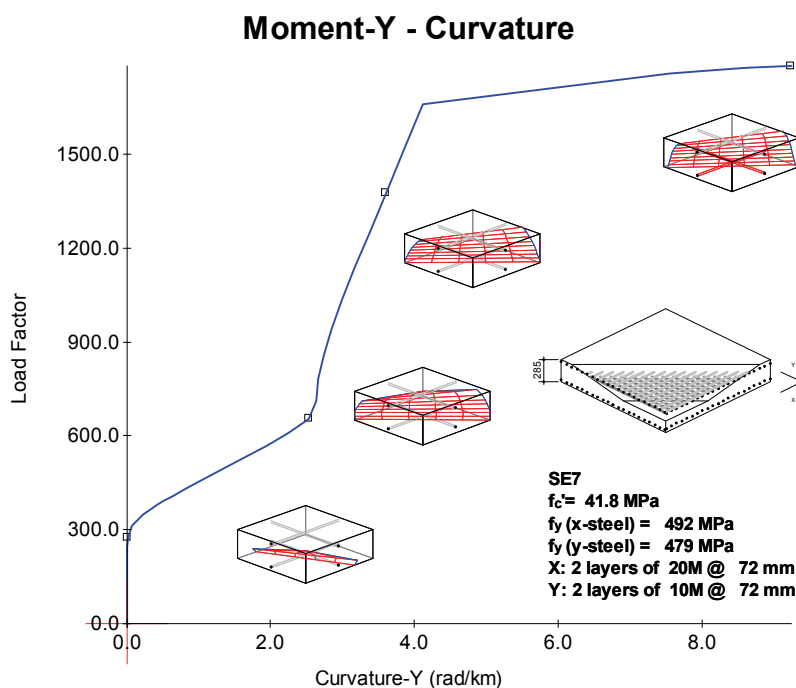

The large load-deformation plots have an additional feature in that they allow other plots to be pasted onto them. The example shown was generated with Shell-2000 in a minute or so. It shows a shell element subjected to in-plane shear and moment. The initial cracks are flexural in nature and as the cracks reach a larger depth, the slope of the moment-curvature plots changes

dramatically. The cracks can be seen in the final form with yielding steel in the last little plot.

The interface of the programs is set up so that there is a “control plot” on the lower left of the screen. (2 control plots in Response-2000). These are used to indicate which part of the analysis is currently being viewed. To change the currently viewed load, click on the control plot and move the crosshairs. Pressing Page-Up and Page-Down will also switch between differently viewed load stages. The button “max/auto range” will automatically adjust the plots to “remember” the maximum scale over the course of the analysis for easier scaling.

## 4-2 Types of Analyses

Three types of analysis are common to all the programs. The first is the “Full-Response” type of analysis. This will first do a single-load level analysis at the values in the left column of the “Loads | Loads” menu choice, and then increase loads in the ratio shown in the right column of the “Loads | Loads” menu item.

The second type of analysis is a “Single Load Level”. This will solve to the loads selected in the left side of the “Loads | Loads” dialog box.

The third type of analysis is a strain state analysis that will return the stress and force state that corresponds to a given set of global strains.

Membrane-2000 also includes explicit options in the solve menu to perform a full analysis for a number of analysis types. These include the Modified Compression Field Theory 1987 (MCFT)<sup>1</sup>, the Rotating-Angle Softened Truss Model (RA-STM) 1993<sup>15</sup>, the RA-STM 1995<sup>10</sup>, the RA-STM 1998<sup>20</sup>, the Fixed Angle Softened Truss Model (FA-STM) 1996<sup>21</sup>, FA-STM 1997<sup>22</sup> and FA-STM 1998<sup>23</sup>. Hsu and colleagues at the University of Houston derived the last 6 methods. They are included in Membrane-2000 for comparison purposes. In general, the six methods from Houston do no better a job than the MCFT, despite having much more experimental data to derive from.

Response-2000 has a number of additional analysis options:

Full Sectional Response	Calculate Moment Curvature as above
More Detail	Interpolate full sectional response to more detail
Member Response	Calculate load-deflection relations for simple beams
One Load	Calculate strains for given M, N, V as above
2 Strain	Calculate stress state for given pair of long. strains
1 Strain	Calculate stress and strain state corresponding to selected strain at certain depth. (e.g. first yield)
M-N Interaction	Calculate axial load-moment interaction envelope
M-V Interaction	Calculate moment-shear interaction envelope. (this is a first step in the Member Response option)
N-V Interaction	Calculate axial load-shear interaction envelope.

Membrane-2000 Response-2000 Triax-2000 Shell-2000

The following section gives a listing of all the 9-plot settings available in the programs. In each case, an example is shown and the description of the 9 plots provides guidance in interpreting analyses. The units listings that goes with each description shows the units used for SI metric, US customary units, and kg-cm units as used in Japan.

### 4-3 Membrane-2000

#### Membrane-2000: 9 Plots General

This is the general page of 9 plots that automatically shows up after completing an analysis. Membrane-2000 is shown with the default analysis of PV20 loaded.

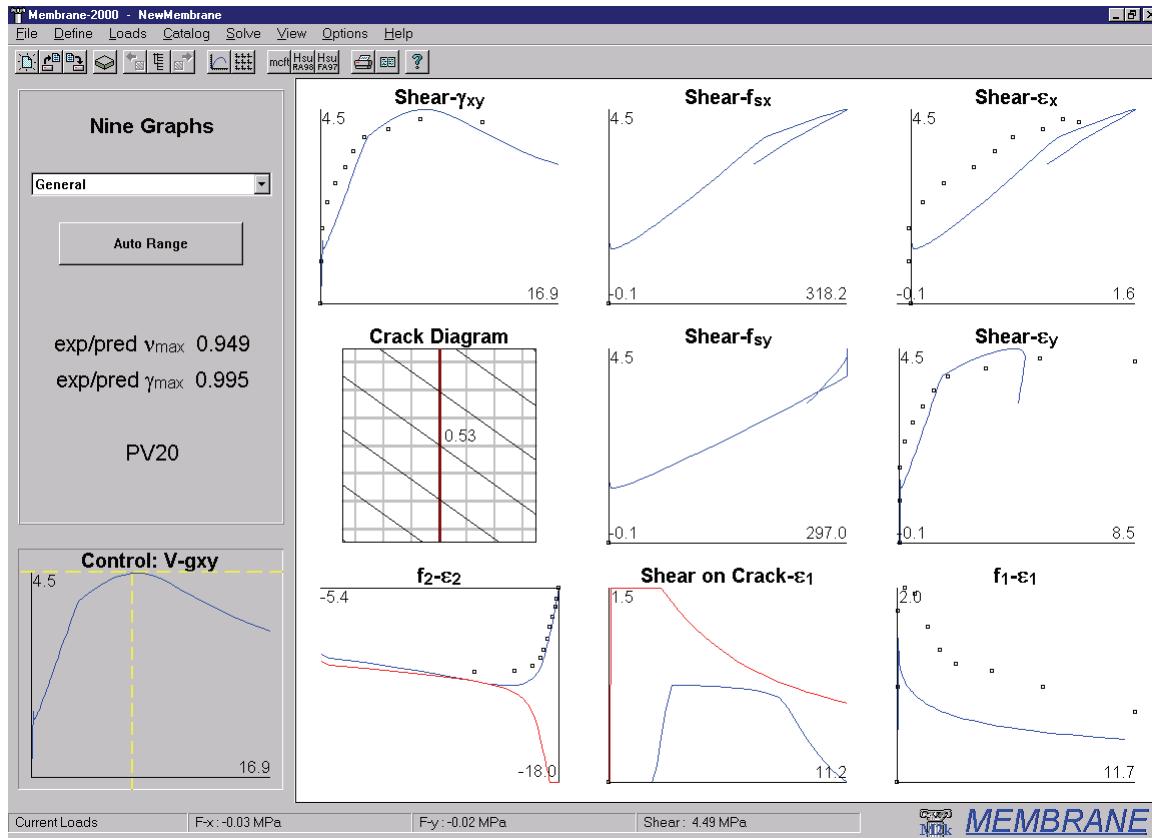

**Shear -  $\gamma_{xy}$**  In-plane shear stress (MPa, psi, kg/cm<sup>2</sup>) vs Shear strain ( $\times 10^{-3}$ )  
 As Membrane-2000 uses shear for all analyses, this summarises the element behaviour. Note cracking, tension stiffening, and crushing at 4.5 MPa in the example

**Shear -  $f_{sx}$**  In-plane shear stress vs X direction Average Steel stress (MPa, ksi, t/cm<sup>2</sup>)  
 The average steel stress may not exceed the yield stress except due to strain hardening. Note the unloading and the change in slope when the y direction steel yields

**Shear -  $\epsilon_x$**  In-plane shear stress vs X direction strain ( $\times 10^{-3}$ )  
 Corresponds to the previous plot with strain as the horizontal axis. Plot is proportional to stress plot, as steel has not yielded in this direction during analysis.



**Crack Diagram** Plot of crack patterns with crack widths (mm, in, cm)

Drawn diagram is 5 x panel thickness wide with steel and cracks drawn in to scale. Note that cracks rotate with analysis, as per MCFT.

**Shear -  $f_{sy}$**  In-plane shear stress vs Y direction Average Steel stress (MPa, ksi, t/cm<sup>2</sup>)  
Same as the above. Note that the steel does not exceed yield (297 MPa).

**Shear -  $\epsilon_y$**  In-plane shear stress vs Y direction strain ( $\times 10^{-3}$ )  
Same as Y direction plot. Note that on unloading, the highly strained steel is assumed to unload at a slope equal to the initial stiffness with a plastic offset.

**$f_2 - \epsilon_2$**  Principal compressive stress (MPa, psi, kg/cm<sup>2</sup>) vs  
Principal compressive strain ( $\times 10^{-3}$ )

This shows the principal stress strain relationship in compression. The red line at the bottom (compression is negative) is the maximum allowable stress, whereas the blue line from the origin is the applied stress. When these two lines touch, the concrete has crushed. The maximum allowable stress gets closer to zero during the analysis due to compression softening implicit in the MCFT. Note the post-peak behaviour in compression implicit from using the Popovics/Thorenfeldt/Collins<sup>5</sup> compression model rather than a parabolic model.

**Shear on Crack -  $\epsilon_1$**  Shear on the crack (MPa, psi, kg/cm<sup>2</sup>) vs  
Principal tensile strain ( $\times 10^{-3}$ )

To satisfy equilibrium at a crack, it is sometimes necessary for shear to exist on the crack surface in the MCFT. This is shown on this plot with  $\epsilon_1$  selected for the X-axis. The red line shows the maximum allowable shear on the crack, a function of the concrete aggregate size and the crack width. In the example, the limit does not control as the lines do not touch. Shear on the crack occurs in this case when the steel stress at a crack reaches yield in the Y direction, and reduces after crushing of the concrete unloads the steel. Note that for elements with steel in only one direction, this relationship controls the strength.

**$f_1 - \epsilon_1$**  Principal tensile stress (MPa, psi, kg/cm<sup>2</sup>) vs  
Principal tensile strain ( $\times 10^{-3}$ )

The principal tensile stress is what separates the MCFT from the earlier Compression Field Theory<sup>11</sup>. Cracked concrete will have no tensile stress at a crack, but significant stresses in between the cracks that will tend to stiffen, though not strengthen, the element. The crack-check of the MCFT shows up in this plot as the tensile stress may be reduced due to equilibrium constraints below the value suggested by the equations. In this case, it isn't controlling as the concrete crushes first.

Membrane-2000: 9 Plots Mohr's Circle

This second page shows a table of all calculated stress and strain terms as well as Mohr's circles of stress and strain.

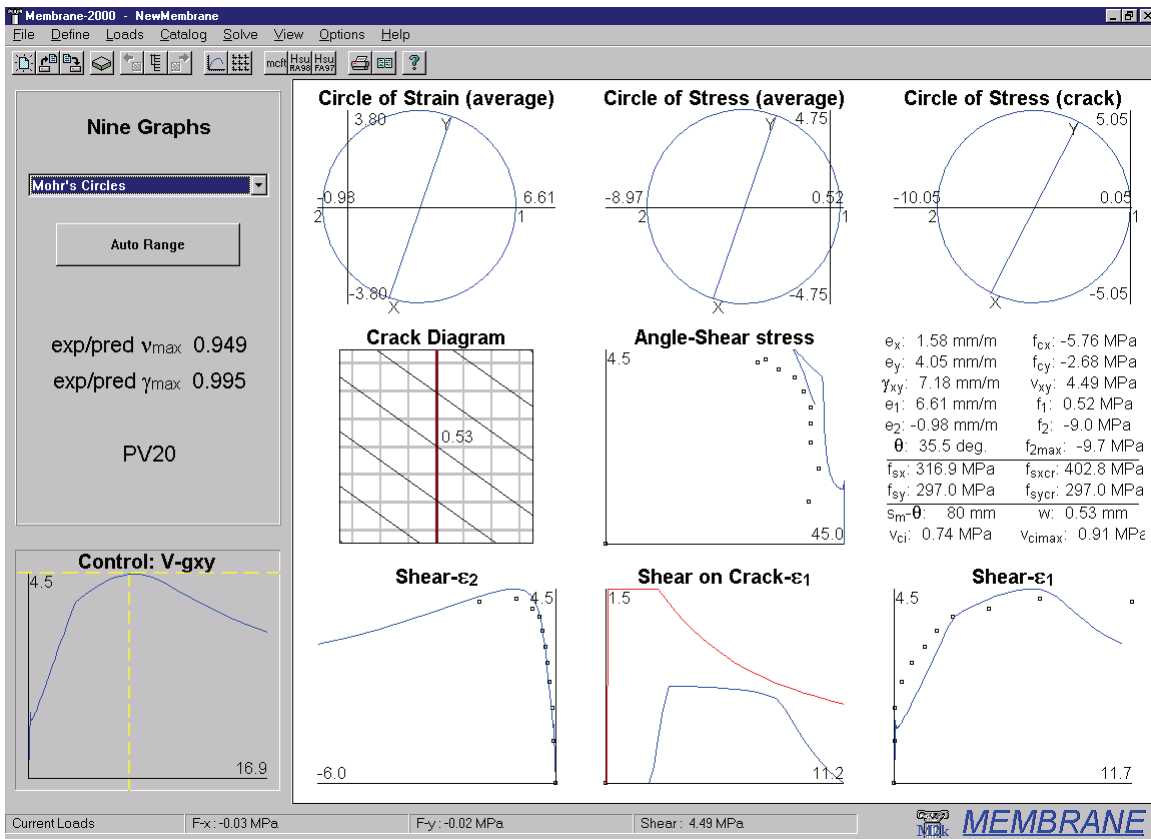

**Mohr's Circle of Strain (average)**

The Mohr's circles are drawn to scale. Unlike all other graphs in this manual, the number listed at the end of the axes represent the intercept of the circle with the axis, rather than the location of the end of the line. These plots update with load level and are shown here for the peak load level. The circle of strain shows the average strain state of the element.

**Mohr's Circle of Stress (average)**

This shows the average stress state used to calculate the behaviour of the element. Note that in the MCFT, though behaviour is calculated and checked at a crack, it is only the average behaviour that affects the final stress-strain state of the element. Note that the angle of the line ( $2\theta$ ) is the same for the stress circle and strain circle as implicitly assumed in the MCFT.

**Mohr's Circle of Stress (at a crack)**

The stress circle at a crack is included to explicitly show the assumptions about what happens at a crack. Note that the angle of the line ( $2 \times$  principal stress angle locally at a crack) isn't the same as it is in the average case. This is due to differing steel stresses

Membrane-2000 Response-2000 Triax-2000 Shell-2000

and principal concrete stresses on average and at a crack. Note that due to this local difference in stress angle, it is quite possible to have shear stress on the crack even though the crack is assumed to be at the same angle as the principal stresses and strains.

**Shear -  $\theta$**  Shear stress (MPa, psi, kg/cm<sup>2</sup>) vs Principal angle of stress/strain (deg)

This shows the angle rotation during the analysis.

**Node-Data** Stress and strain state of panel at given load stage (units shown)

By right clicking, it is possible to copy this data to the Windows clipboard for use in other applications.

**Shear -  $\epsilon_2$ , Shear -  $\epsilon_1$**

Similar to graphs on first page of 9 plots, but with shear as vertical axis.

*Membrane-2000: 9 Plots Rebar and Cracks*

This final page of 9 plots from Membrane-2000 shows important details of the MCFT in the average steel stress and steel stress at a crack plots.

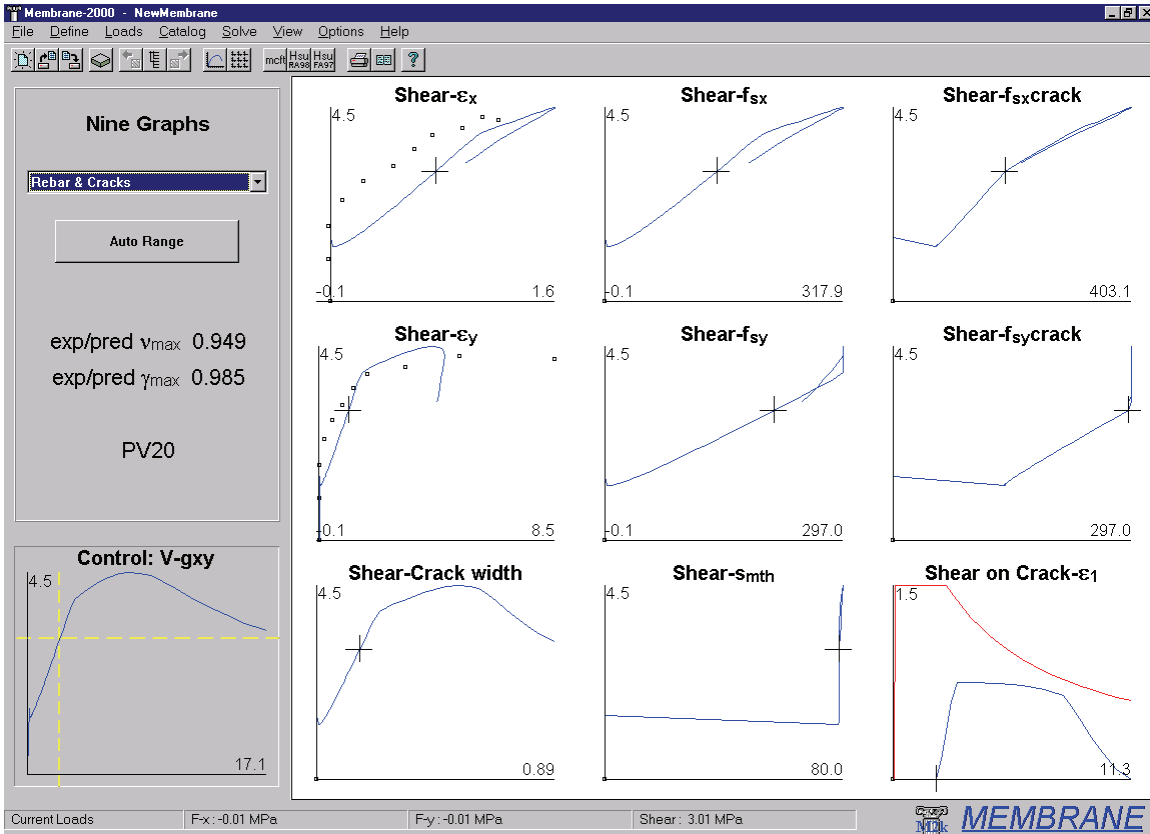

The important thing to note about this page is the “stress at a crack” plots. The crosshairs in the control chart have been selected here to be just before shear on the crack is required. This can be seen on the centre right plot where the cross is just before yield

in the weak (Y) direction. This is an assumption of the MCFT; no shear on the crack is needed until steel first yields at a crack in the weaker direction. Put another way, the shear on the crack is minimised in the MCFT as it is assumed that the reinforcement mechanism is stiffer.

As the load increases above that point, the stress at a crack in the Y direction is limited to the yield value, and the average is allowed to continue to increase towards yield. Together this means that the amount of shear on the crack must increase to continue to support the principal tension. Note that as the load increases above the current level, the rate of change of the stress at a crack in the X direction changes. Shear on the crack acts to transfer reinforcement demand at a crack from the weak direction (Y) to the strong direction (X), so shear on the crack makes the slope change. If the load could continue to increase higher, in this case it's governed by crushing of the concrete, and the steel stress in the strong direction also reached yield, the principal tensile stress would be lowered to ensure equilibrium could be maintained locally at a crack. That, in a nutshell, is the point of the crack check in the MCFT.

## 4-4 Response-2000

### *Response-2000 9 Plots General*

Response-2000 draws plots over the depth of the beam of column. This example shows a sectional analysis with shear and moment on a prestressed single-Tee beam.

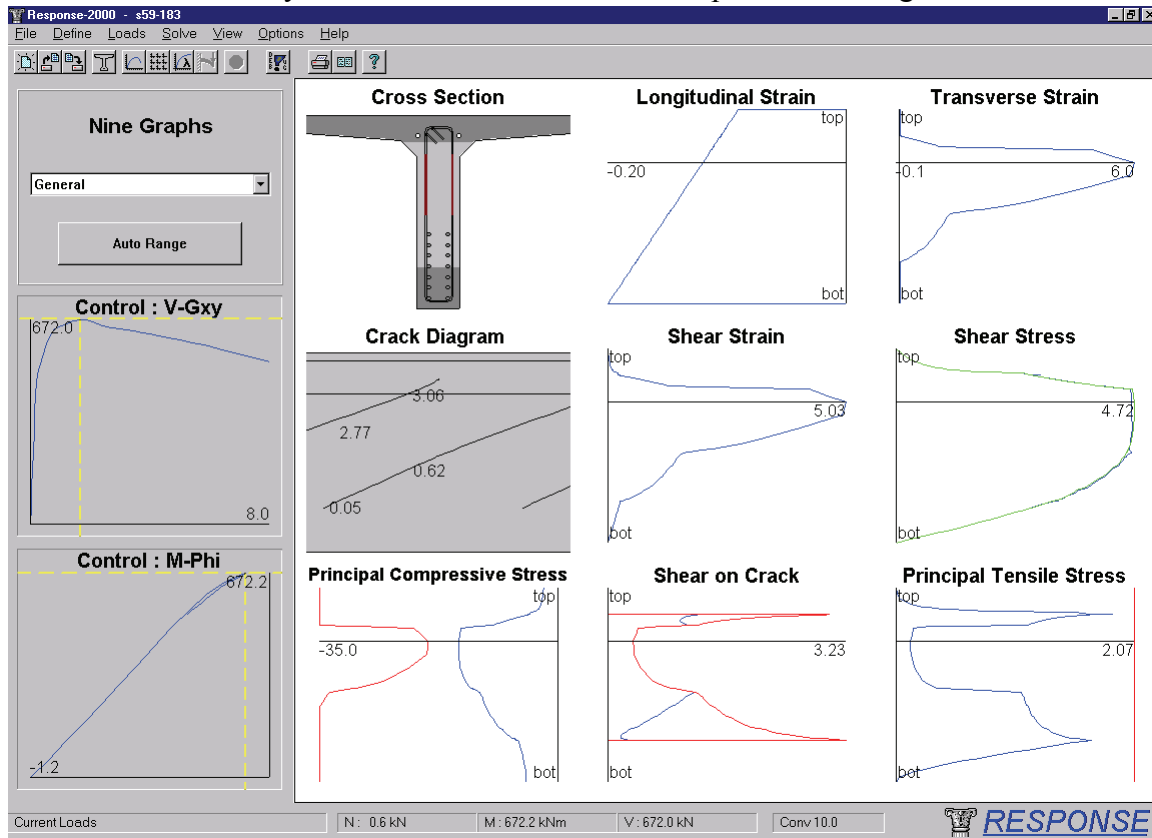

Response-2000 uses two control plots. They are selected based on the type of loading, but for shear analyses, the top one shows shear versus shear-strain plot and the bottom one shows the moment curvature plot. This quickly allows detection of shear failures versus flexural failures. In this case, due to the prestressing, the moment curvature never actually reaches a positive curvature, but the shear plot has started descending indicating a shear failure, in this case before even full depth cracking of the section. The plots show the behaviour just before failure.

### **Cross Section**

The cross section is drawn darker in regions where the concrete hasn't cracked. Longitudinal reinforcement and stirrups are drawn dark red if on the yield plateau, bright red if strain hardening, and dark and bright green for yielding in compression. In this case, note that despite the positive moment on the section, the bottom of the section hasn't cracked through yet due to the prestress force.

**Longitudinal Strain** Longitudinal strain ( $\times 10^{-3}$ ) vs section depth

This confirms that the curvature is still negative in the section. Note that the line is linear, showing the implicit assumption that plane sections remain plane. Right clicking on this plot and selecting “toggle text” will show or hide the curvature of the beam.

**Transverse Strain** Bulging strain ( $\times 10^{-3}$ ) vs depth of section

While the longitudinal strains must be linearly distributed, the transverse strain depends on the local stress-strain conditions at each point in the depth of the beam. They are dictated by the assumption that the total vertical stress at every depth of the beam must be zero. In this failure condition note the high strains ( $\sim 3 \times$  yield strain) near the top of the web.

**Crack Diagram**

This plot shows the estimated crack pattern as well as crack widths (mm, in, cm). Note that the crack widths as well as patterns are rather approximate and should not be used alone to estimate the health of a structure. For this beam about to fail, the maximum crack width is predicted to be 3.0 mm. For cases where part of the concrete is crushing, the section is redrawn in pink, and for sections where the cracks are slipping causing failure, the section is drawn in purple.

**Shear Strain** ( $\times 10^{-3}$ )

Like the transverse strain, this shows the distribution of shear strain in the section. If the section starts to unload for any reason, a grey envelope will show the maximum value attained so far.

**Shear Stress** (MPa, psi,  $\text{kg}/\text{cm}^2$ )

Shear stress is calculated in Response-2000 by a process that considers the longitudinal stiffness of the cracked concrete<sup>2</sup>. This produces a calculated shear stress profile for each load level. This calculated shear stress profile is shown on the plot in green, and the stress from the strain state is shown in blue. Generally these two lines will match very closely, but if they don't, the load stage should be treated with some caution. Note that the shear stress is zero at the top and bottom faces of the beam as expected, but that the shear stress distribution isn't the width-modified parabola that linear theory would predict. The calculated shear-stress profiles for cracked reinforced concrete in general are more complex than linear theory would predict, having important effects on predicted behaviour.

**Principal Compressive Stress** (MPa, psi,  $\text{kg}/\text{cm}^2$ )

Principal compressive stress over the depth is shown in the bottom left. The maximum allowable stress is shown in red at left. This number will reduce due to cracking in the concrete as predicted by the MCFT. The blue line is the applied stress in the concrete at each depth in the beam. Note that due to the shear inducing diagonal compression, it is quite possible to have principal compression over the entire depth of the beam. The stress in this beam is more due to the prestressing, however. If the red and blue lines touch, the concrete is predicted to crush and the section will fail. That is

---

 Membrane-2000 Response-2000 Triax-2000 Shell-2000
 

---

the fate of this beam. At the next load stage, the concrete is crushing at the top of the web.

**Shear on the Crack** (MPa, psi, kg/cm<sup>2</sup>)

Cracked concrete may require shear on the crack to maintain the principal tensile stress in the concrete. See the Membrane-2000 section above for a discussion of this. As in that section, the maximum allowable shear on the crack is shown in red with the applied in blue. For this section, the maximum is limiting the shear on the crack over part of the depth. In that region, the principal tensile stress has been lowered to maintain equilibrium.

**Principal Tensile Stress** (MPa, psi, kg/cm<sup>2</sup>)

This tensile stress will exist throughout the beam, caused by shear on the cross section. Note the location where the stress is reduced due to the shear on the crack limitation. The red line on the right indicates the maximum value of stress allowed due to the requirement of longitudinal yield. If this line pulls in diagonally and intersects the blue applied stress line, the section is approaching flexural failure.

*Response-2000 9 Plots Cracking*

This page of 9 plots in Response-2000, not shown here, contains plots of:

**Cross Section** as above

**Longitudinal strain** as above

**Principal tensile strain** ( $\times 10^{-3}$ )

**Crack diagram** as above

**Crack width** plot (mm, in, cm)

**Average Angle** with depth (degrees)

**Longitudinal Crack Spacing** (mm, in, cm)

**Transverse Crack Spacing** (mm, in, cm)

**Diagonal Crack Spacing** (mm, in, cm)

Response-2000 calculates crack spacing based on the angle and the estimate of crack spacing in the longitudinal and transverse directions as per the MCFT. If the crack spacing is calculated automatically as suggested, the spacing will vary over the depth of the section, further improving the realism of the analysis.

*Response-2000 9 Plots Reinforcement*

This page shows the state of the reinforcement in the longitudinal and transverse direction. The following plots are included:

**Cross Section** as above

**Longitudinal strain** as above

**Transverse strain** as above

**Longitudinal Reinforcement Stress** (MPa, ksi, t/cm<sup>2</sup>) This the average stresses

**Longitudinal Reinforcement Stress at a crack** (MPa, ksi, t/cm<sup>2</sup>)

This local value includes the effects of the shear on the crack and principal tension.

**Longitudinal Average Bond** (MPa, psi, kg/cm<sup>2</sup>)

This bond stress is what the reinforcement must be able to withstand in order to support the given shear. No limitations are made in Response-2000 if this value becomes unrealistically high.

**Stirrup Stress** (MPa, ksi, t/cm<sup>2</sup>)

This shows the average stress in the stirrups over the beam depth.

**Stirrup Stress at a Crack** (MPa, ksi, t/cm<sup>2</sup>)

This is the local stress at a crack mandated by equilibrium considering shear on the crack and principal tensile stresses.

**Transverse Average Bond** (MPa, psi, kg/cm<sup>2</sup>)

As the stress is changing along the length of the stirrups, it is possible to calculate the bond stresses that would need to be resisted by the stirrup. Response-2000 calculates these but does not use them to affect the analysis at all. In cases where a stirrup enters the top flange of a T-Beam, for example, there will be a large drop in stirrup stress due to the increased concrete area, resulting in a very large calculated bond. The real bond would be much lower due to strain penetration, and shear lag of forces entering the top flange.



Membrane-2000 Response-2000 Triax-2000 Shell-2000

Response-2000 9 Plots No Shear

For analyses without any shear, Response-2000 automatically shows a special 9-plot page for that case shown below for a beam under axial compression and shear.

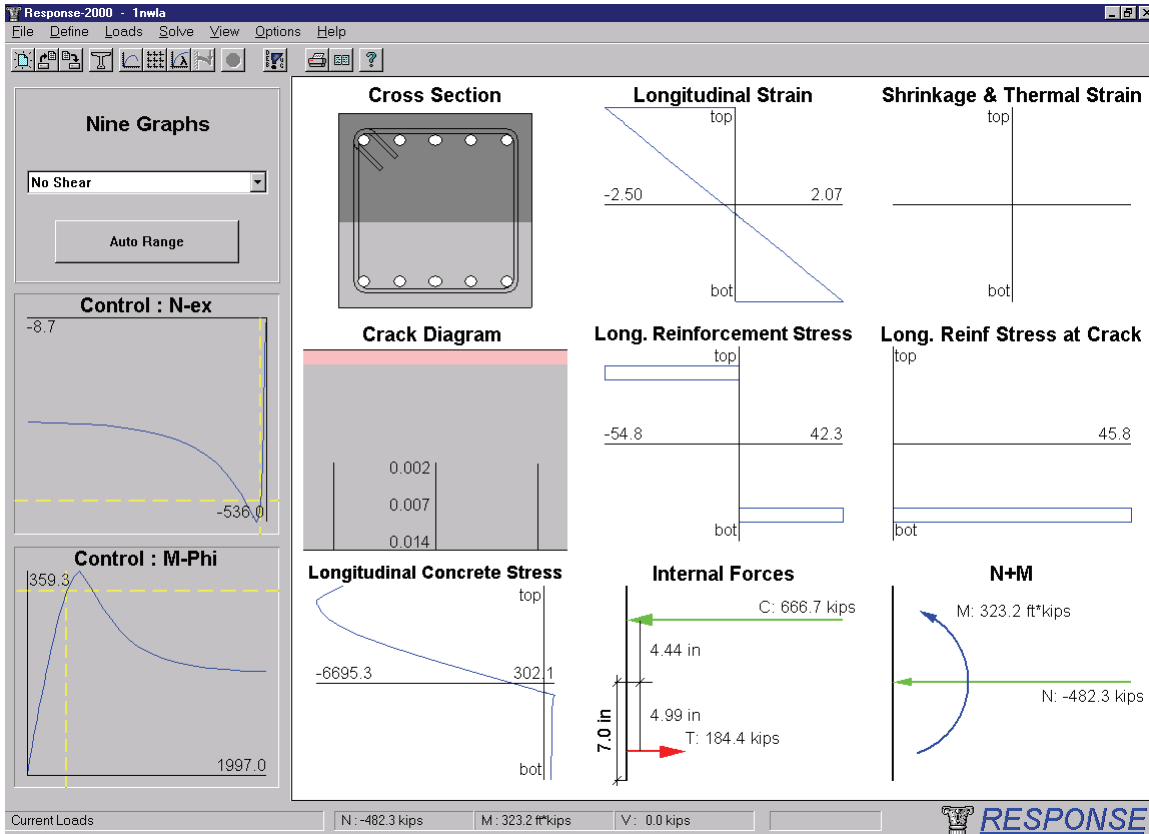

This page has 2 new graphs that have not been explained yet.

The **Internal Forces** plot shows the force and location of the compressive and tensile forces in the cross section. In this case, due to the axial load, they do not balance each other. Note that the tensile force arrow may not come directly from the steel location due to the concrete tensile force component. By right clicking on the plot, another mode may be selected that calculates directly the resultant of the steel and concrete forces. This can produce counterintuitive results, so isn't the default mode of presentation.

The **N+M** plot shows the moment and axial force drawn simply as arrows. This helps in finding mistakes in simple things such as the sign of the axial force.

### Response-2000 Load Deformation Plots

The example below shows the screen of Response-2000 in the load-deformation plot mode. The figure shows the AASHTO-99 moment-shear interaction diagram for a column tested at the University of Toronto in the 1970's by Aregawi<sup>24</sup>. This figure contains a great deal of information and so will be explained in detail.

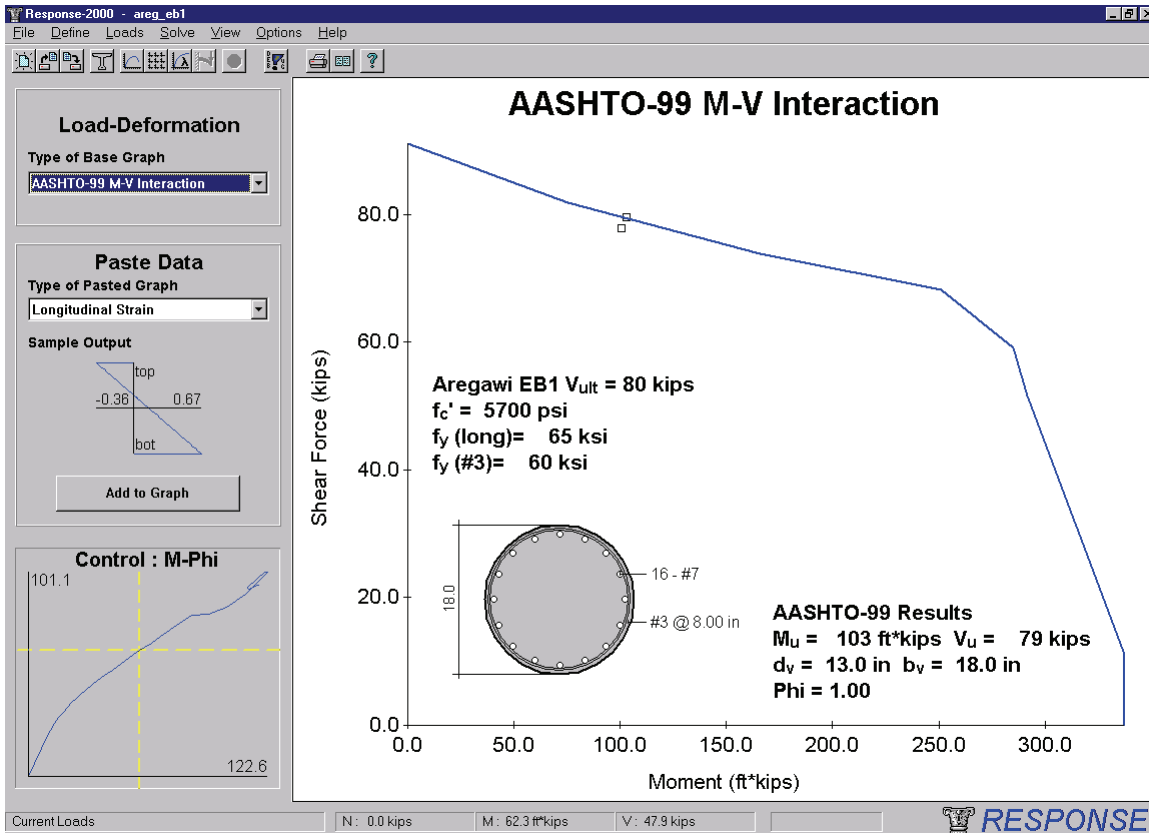

### Response-2000 Interface Issues

This page of results is selected with the toolbar icon with the lambda ( $\lambda$  – signifying load factor) beside the little 9-plot icon or from the “View | Load Deformation Plot” menu.

The background plot is selected in the top left of the screen. Currently it is selected to the AASHTO-99 LRFD M-V interaction diagram. Below that option is the “Paste Data” section that allows selection of which plots to paste onto the plot. The figure at the start of the section showing cracked shell elements on the main figure was prepared this way with Shell-2000. Currently selected is the longitudinal strain profile, with the current levels controlled by the control plot below. Pressing the “add to graph” button would paste the picture on the main figure where it could be moved and resized.

The main figure contains a pair of text-boxes as well as a diagram of the element. The element picture is pasted on via the “Options | Insert Beam Diagram” menu option. By right clicking on the figure, the dimension text may be resized and copied to the

clipboard etc. The top text was automatically prepared by Response-2000 and inserted with the “Options | Insert Text Box” option. This text box may also be edited and customised. The bottom right text box was automatically included by Response-2000 to provide information on how the AASHTO-99 analysis was calculated.

### **Analysis Results Issues**

The AASHTO-99 page (there is also an AASHTO-94 LRFD page) automatically calculates the strength of the section and prints it in the text box, in this case in the bottom right. It can be seen that the ultimate shear capacity ( $V_u$ ) was predicted as 79 kips. This is calculated for the ratio of moment to shear selected from the “Loads | Loads” dialog box. Note that there is a little box on the interaction curve at the point it calculates failure at. In this case, it is on the top curve part of the envelope meaning a shear failure is predicted.

There is an additional little box shown just below the envelope, this is the maximum load that the Response-2000 analysis was able to achieve. In this case they are very close, but they can vary more widely. If the Response-2000 prediction is outside the envelope, it suggests that the AASHTO code is conservative compared to the more advanced predictions that Response-2000 makes. If the Response-2000 prediction is within the envelope, it suggests that the code is unconservative compared to the Response-2000 analysis. This provides a second, independent, checking of the provisions of the code that can add to engineer’s confidence for strength predictions of unusual geometry.

It is noted in the top text box that this particular column happened to fail experimentally at a shear of 80 kips, which is in excellent agreement with both the Response-2000 predictions and the code prediction. See Reference 2 for more discussion of the experimental verification of Response-2000.

*Other Load-Deformation Plots*

Response-2000 also has the following load-deformation plots.

- Shear/Moment VS longitudinal strain at mid-depth
- Moment-Curvature
- Moment-Maximum Crack Width
- Moment-Maximum Reinforcement Strain
- Shear-Maximum Crack Width
- Shear-Shear Strain
- Shear-Transverse Strain
- Interaction Diagrams (M-V, N-V, M-N depending on which is calculated)

*Response-2000 Full Member Plots*

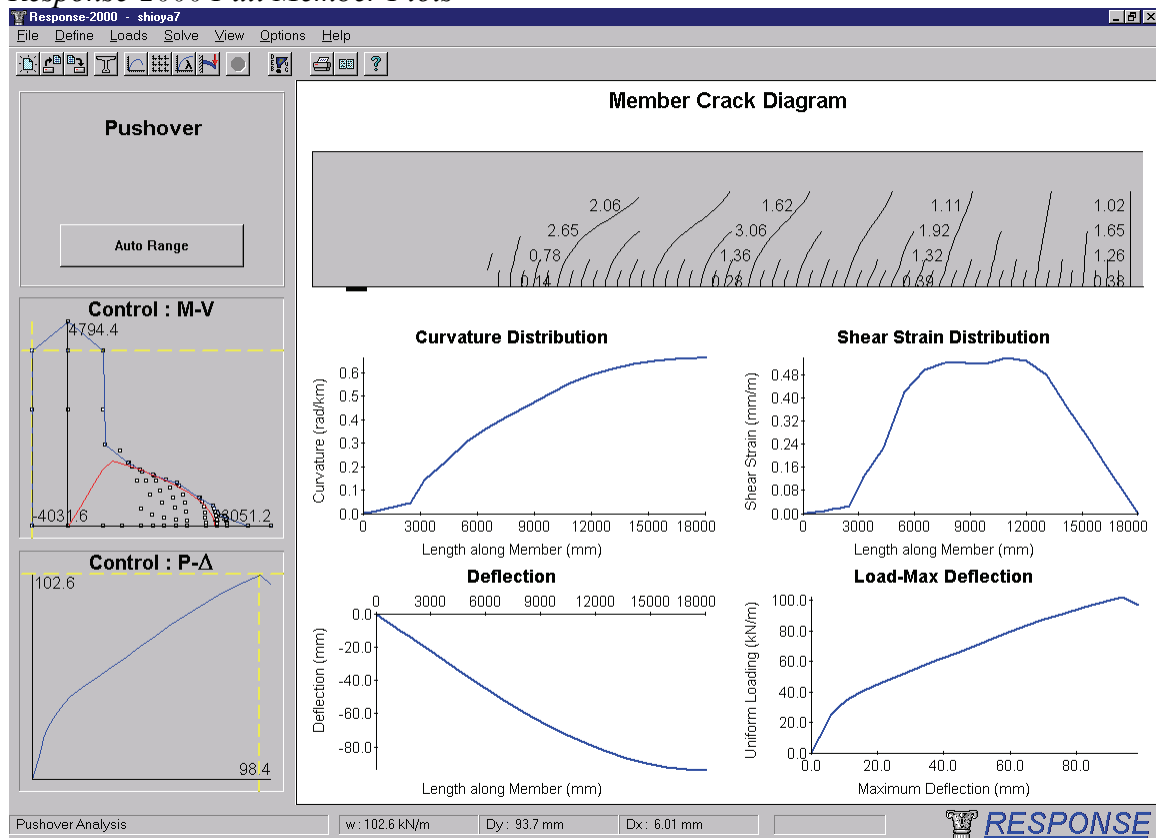

One of the features of Response-2000 is that while internally it is a sectional analysis program, it is able to connect a number of sections to perform simple member analysis. The shown example is for the largest beam ever tested in shear, tested by Shioya et al in Japan<sup>25</sup>. This beam had an effective depth of 3000 mm (10 feet), and was 36 metres long (120 feet). The beam was subjected to a uniformly distributed loading.

To perform the shown Response-2000 analysis, the section was first entered into the program. Next, the “Loads | Full Member Properties” option was used to select a length of 18 metres (Response-2000 does the analysis on the half-length of the beam),

and the loading was switched to a uniformly distributed load. Finally, the “Solve | Member Response” menu option was selected.

Response-2000 calculated the interaction diagram shown in the top control chart. It then determined the largest loading envelope that would fit into the diagram. It can be seen that the loading envelope touches the failure envelope on the top indicating a shear failure. If it had touched at the right side, it would have represented a flexural failure. The shape of the loading envelope is parabolic on the right and linear on the left. See Reference 2 for a description of the derivation of the loading shape.

The shown crack diagram is the predicted extent of cracking in the beam at failure. The support plate can be seen on the left. The loading is uniform over the top surface of the beam. Using the lower control plot, the predicted extent of cracking at other load levels may also be explored.

The plots at the bottom are also instructive. The top left one shows the change in curvature over the length of the beam. The location of first flexural cracking, about 2500 mm from the support, can be clearly seen as can the roughly parabolic distribution that would be expected for the parabolic moment diagram. Note that these curvatures all implicitly include the effect of shear on the curvature.

The shear strain distribution shows that the average shear strain over the length of the beam isn't uniform at all. It may be expected that the strain would increase linearly from the right as the shear diagram is linear, but this isn't the case due the concrete non-linearity. The strong interaction of shear and moment for this beam means that the predicted critical location for shear is about 6 metres away from the location of maximum shear.

Rounding out the plots are the predicted deflected shape and the plot of load versus deflection for the beam. Note that the failure is predicted at a load of 102.6 kN/m and a deflection of about 100 millimetres. The experimental failure load was measured as 105 kN/m, at a deflection of about 100 millimetres.

## 4-5 Triax-2000

### Triax-2000 9 Plots General

Triax-2000 has a total of 8 different 9-plot screens. These will not all be shown here as there is a fair amount of repetition between them.

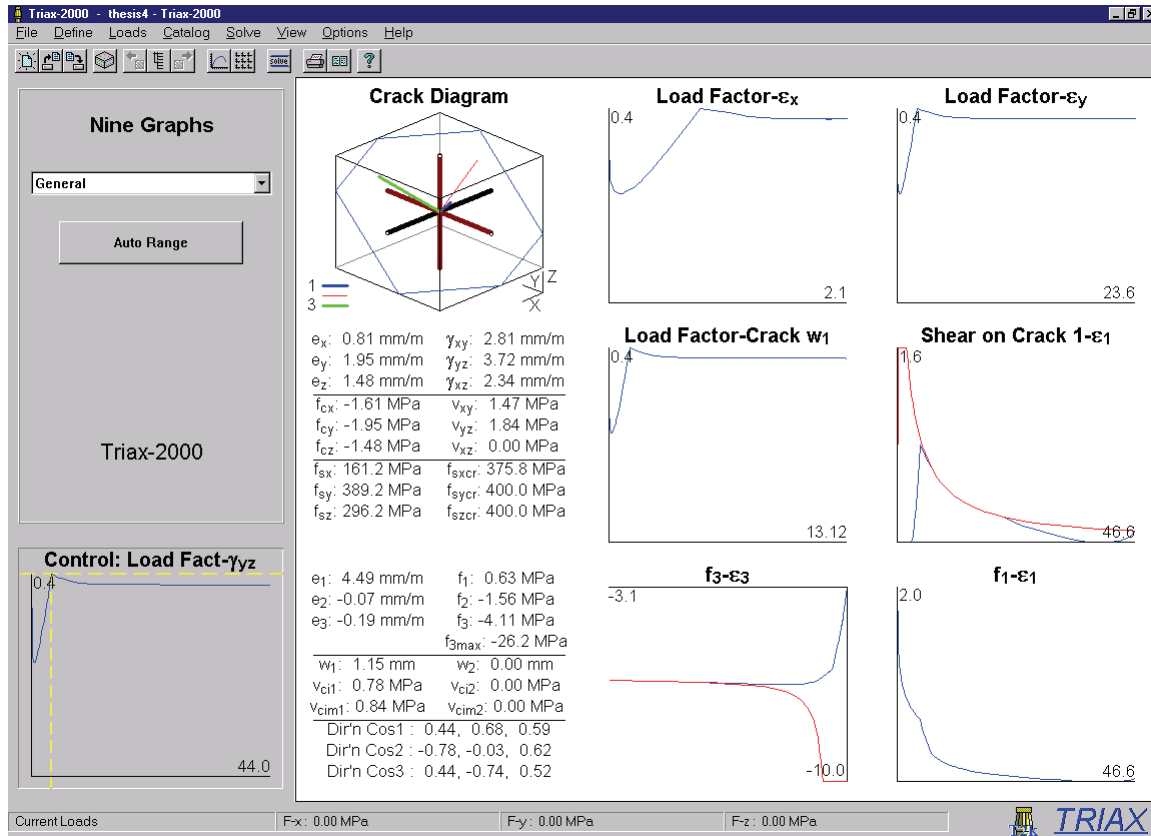

The example shows a block of 40 MPa concrete with 1 % of 400 MPa steel in the X direction, and 0.5% of 400 MPa reinforcement in the Y and Z directions. The loading is a full response with 4 units of shear stress in the X-Y direction and 5 units in the Y-Z direction.

### Crack Diagram

This shows the block of concrete with the reinforcement drawn in. The reinforcement is given the same colouring rules that Response-2000 has. The directions of the vectors of principal stress/strain are drawn in as well, thick blue for the principal tensile direction, thick green for principal compressive direction and red for the intermediate direction. If the concrete is cracked, the intersection of the crack plane with the bounds of the box is shown with colours representing the principal direction, in this case blue due to it being the first principal tensile direction.

---

 Membrane-2000 Response-2000 Triax-2000 Shell-2000
 

---

**Load Factor -  $\epsilon_x$**  load factor VS average strain in X direction ( $\times 10^{-3}$ )

The general variable used for Y-axes in Triax-2000 is the load factor. This means that the actual values of loading must be known. This plot shows the variation of the x-direction strain with load factor.

**Load Factor -  $\epsilon_y$**  load factor VS average strain in Y direction ( $\times 10^{-3}$ )

Note the high strain in this case indicating yielding of the y direction steel.

### Node-Data 1 and 2

Like Membrane-2000, Triax-2000 provides a page that shows the internal stress and strain state of the element. For the 3D case, this presentation is sufficiently important to be on almost all of the 9-plot cases. With a right click on each of the 2 pages of numbers, the data may be copied to the clipboard for use in other programs.

**Load Factor- Crack width 1** load factor VS crack width 1 (mm, in, cm)

Crack widths are shown here for the first principal direction of cracking. Note that there may well be more cracks in the second principal direction and, in the absence of shear, on the third direction also.

**Shear on Crack 1 –  $\epsilon_1$**  Shear on crack (MPa, psi, kg/cm<sup>2</sup>) vs  $\epsilon_1$  ( $\times 10^{-3}$ )

This shows the magnitude of the 3D vector of shear on the crack and compares it to the maximum allowable level shown in red. In this example, the shear on the crack criterion is controlling where the two lines touch.

**$f_3 - \epsilon_3$**  Principal compressive stress (MPa, psi, kg/cm<sup>2</sup>) vs  
Principal compressive strain ( $\times 10^{-3}$ )

This shows the health of the concrete against crushing. When these two lines touch, the concrete is crushing. In this case, this happens after yield of the Y and Z direction steel.

**$f_1 - \epsilon_1$**  Principal tensile stress (MPa, psi, kg/cm<sup>2</sup>) vs  
Principal tensile strain ( $\times 10^{-3}$ )

This compares the health of the concrete against yield of the steel and shear on the crack. If equilibrium requires that the tensile stress be reduced due to the capacity of the steel at a crack or the ability of the crack surfaces to resist shear, it will show up on this plot. In the example, the drop in principal tension is caused the shear on the crack relationship seen to be critical above.

### *Triax-2000 Other 9-plot Views*

**Cracking:** This 9-plot view shows the principal strains ( $\times 10^{-3}$ ), crack widths (mm, in, cm) and shear on crack resultants (MPa, psi, kg/cm<sup>2</sup>), for cracks in principal directions one and two.

**Direction Cosines** This shows the state of the three direction cosines in each of the three principal directions with respect to load factor. These are the numbers used to draw the vectors in the crack diagram above.

**Principal** This page shows the three principal strains ( $\times 10^{-3}$ ) and three principal stresses (MPa, psi, kg/cm<sup>2</sup>) in the concrete.

**Reinforcement** This group of 9-plots shows the steel stresses on average and at a crack (MPa, ksi, t/cm<sup>2</sup>) in the X, Y and Z directions. Note that the discussion above for Membrane-2000 concerning shear on the crack also applies to effects in three dimensions such as these cases.

**Shear on the Crack** This page shows the 3D components of the shear on the crack (MPa, psi, kg/cm<sup>2</sup>) for the first and second principal cracking direction. These values are calculated using a non-linear optimisation function based on quadratic programming. It minimises to the shear on the crack required, an extension of the 2D method explained above for Membrane-2000.

**Strain State** This shows the load-factor vs the 6 rectangular strains. ( $\epsilon_x, \epsilon_y, \epsilon_z, \gamma_{xy}, \gamma_{yz}, \gamma_{xz}$ , all  $\times 10^{-3}$ )

**Stress State** This shows the load-factor vs the 6 rectangular stresses. ( $f_{cx}, f_{cy}, f_{cz}, v_{xy}, v_{yz}, v_{xz}$ , all in MPa, psi, kg/cm<sup>2</sup>)



## 4-6 Shell-2000

### Shell-2000 9 plots General

Like Triax-2000, the 3D nature of Shell-2000 results in eight 9-plot screens. Shell-2000 is shown with Shell element SP2 tested by Adebar<sup>26</sup> with loading ratios of moment  $M_x = M_y = 0.5$  and out of plane shear  $V_{xz} = V_{yz} = 1.0$ . This element contained a light amount (53 psi = 0.37 MPa) of transverse reinforcement.

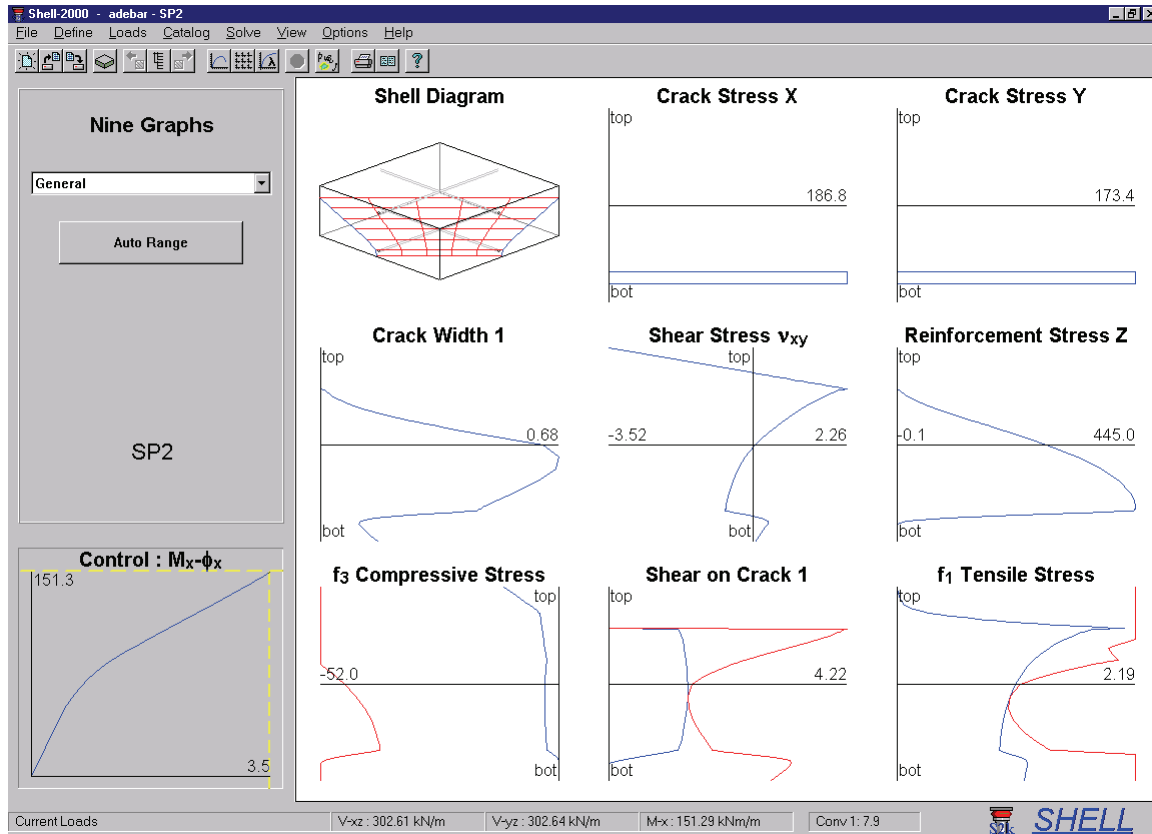

It can be seen that the combination of the two moments and shears has caused the direction of cracking to rotate to 45 degrees away from the steel directions. The applied loading at predicted failure is  $V_{xz} = V_{yz} = 303$  kN/m. In this case, this corresponds to a principal shear of  $303 \times 1.414 = 428$  kN/m. In the experiment, the element failed at a principal shear of 449 kN/m.

### Shell Diagram

The crack diagram shows the extent of cracking in the shell element. Bars are drawn and turn red or green when yielding as in the other programs in this manual. The first principal direction crack is drawn in red and the second principal direction crack is drawn in green. The Crack diagram is shown below responding to each of the different type of loading to assist in interpreting what it means.

**Crack Stress X** stress at a crack in X direction steel (MPa, ksi, t/cm<sup>2</sup>)

This is useful to identify if the section is being governed by flexural behaviour. In this case, it is not as the stresses are much lower than the 480 MPa strength of the steel.

**Crack Stress Y** stress at a crack in Y direction steel (MPa, ksi, t/cm<sup>2</sup>)

Same as above

**Crack Width 1** width of crack in first principal direction (mm, in, cm)

This shows the crack width distribution over the element

**Shear Stress V<sub>xy</sub>** In plane shear distribution with depth (MPa, psi, kg/cm<sup>2</sup>)

Shell elements can be subject to internal in-plane shear stresses even when not externally loaded in in-plane shear. The example shows that in this case there is up to 3.5 MPa of in-plane shear even though the resultant of the positive and negative in-plane shear is zero. The resultant of the twisting moment caused by this shear is also zero as there is no external twisting moment applied.

**Reinforcement Stress Z** Stress in shear reinforcement on average (MPa, ksi, t/cm<sup>2</sup>)

This indicates how closely the structure is to shear failure by yield of the transverse reinforcement. In this case, the strength of the shear reinforcement is 460 MPa, so the steel is close to yielding.

**f<sub>3</sub> Principal Compressive Stress** Distribution of compression (MPa, psi, kg/cm<sup>2</sup>)

This indicates how closely the concrete in the structure is to crushing. If the red line at the left touches the blue line at the right, the concrete is crushing. In this case, failure is not governed by crushing.

**Shear on Crack – $\epsilon_1$**  Shear on crack (MPa, psi, kg/cm<sup>2</sup>) vs  
Principal tensile strain ( $\times 10^{-3}$ )

As with the other programs, this indicates how much equilibrium dictated shear on the crack must be present over the depth of the element. The red line indicates the maximum allowable stress based on the aggregate size and the crack width at that depth. If the two lines touch, as they have just done in the example, the principal tensile stress will be reduced to ensure that equilibrium can be maintained. In the example, the initiation of crack slip represents the maximum load the element can maintain. As noted above, the transverse reinforcement is almost at yield already, so any increase in demand on the steel, due to crack slip, cannot be supported. If the structure had more transverse steel, this would not be the case. Note, however, that this inclusion of only 53 psi of stirrups to the shell increased its predicted shear capacity by 20% over the case with no transverse reinforcement.

**f<sub>1</sub> Tensile Stress** Principal tensile stress (MPa, psi, kg/cm<sup>2</sup>)

This shows the distribution of tension in the principal tensile direction over the element in blue, with the maximum allowable tension from equilibrium drawn in red. In this case it can be seen that the shear on the crack limitation is cutting in and about to force the tensile stress to be reduced inducing failure. If the specimen is experiencing

---

 Membrane-2000 Response-2000 Triax-2000 Shell-2000
 

---

flexural style failure, the red line will cut in diagonally. If it is experiencing shear on the crack style behaviour, the line will cut in matching the shear on the crack graph.

### *Shell-2000 9-Plot Views*

**Cracking:** This 9-plot mode shows the base and diagonal crack spacings (mm, in, cm) as well as the crack widths (mm, in, cm) and shear on the crack resultants (MPa, psi, kg/cm<sup>2</sup>), for cracks in principal directions one and two.

**Direction Cosines** This shows the state of the three direction cosines in each of the three principal directions with respect to depth. These are the numbers used to draw the crack surface in the shell diagram.

**Principal** This page shows the principal strains ( $\times 10^{-3}$ ) and principal stresses (MPa, psi, kg/cm<sup>2</sup>) with respect to depth.

**Reinforcement** This shows the steel stresses on average and at a crack as well as bond stresses (MPa, ksi, t/cm<sup>2</sup>) in the X, Y and Z directions. The bond is discussed above in the Response-2000 section on bond. The discussion above for Membrane-2000 concerning shear on the crack also applies to effects in three dimensions such as these cases.

**Shear on the Crack** This page shows the 3D components of the shear on the crack (MPa, psi, kg/cm<sup>2</sup>) for the first and second principal cracking direction. These values are calculated using a non-linear optimisation function based on quadratic programming. It minimises to the shear on the crack required.

**Strain State** This shows the 6 rectangular strains through the depth of the element.  
( $\epsilon_x, \epsilon_y, \epsilon_z, \gamma_{xy}, \gamma_{yz}, \gamma_{xz}$ , all  $\times 10^{-3}$ )

**Stress State** This shows the 6 rectangular stresses through the depth of the element.  
( $f_{cx}, f_{cy}, f_{cz}, v_{xy}, v_{yz}, v_{xz}$ , all in MPa, psi, kg/cm<sup>2</sup>)

*Shell-2000 Interpreting Crack Diagrams*

The following figures show a series of crack diagrams from Shell-2000 to demonstrate what some of the standard crack patterns look like. This should help in determining if a given crack pattern is consistent with the desired loading.

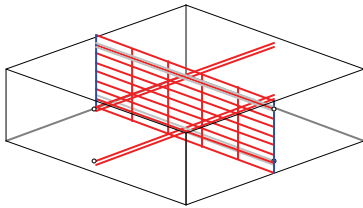

X Direction Axial tension

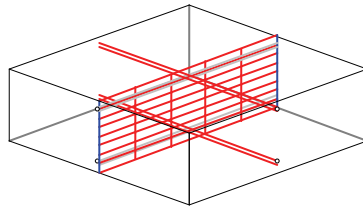

Y Direction Axial Tension

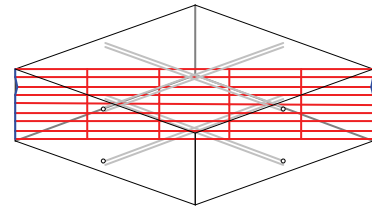

Positive in-plane (X-Y) Shear

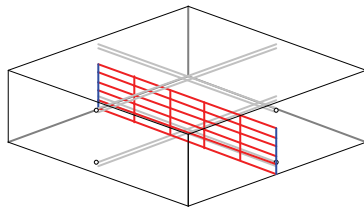

Positive X-Moment

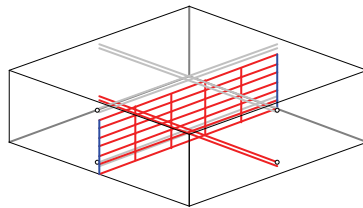

Positive Y-Moment

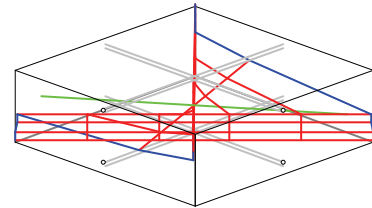

Positive Twisting Moment

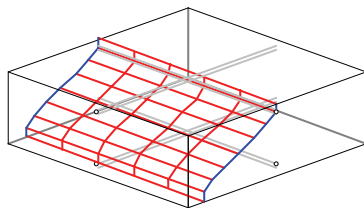

Positive X-Z Shear

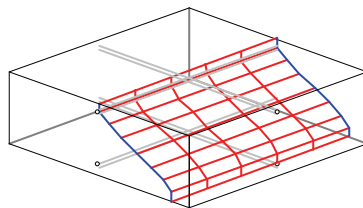

Positive Y-Z Shear

Combinations of loading:

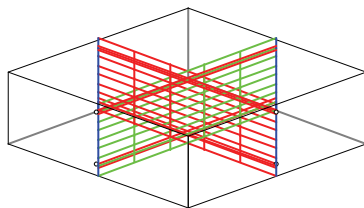

Axial load in X and Y direction  
Two crack planes form at 90 degrees.

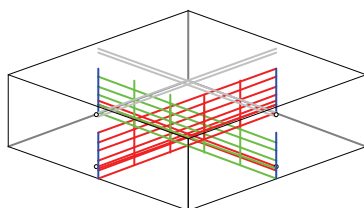

Biaxial Moment same sign, no shear  
Similar to above, but cracks are not full depth.

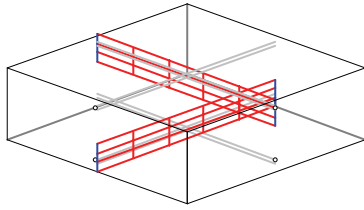

Biaxial moment, different sign, no shear  
 Similar to above, but cracks start on opposite side of element. When cracks meet at mid-depth, the first principal direction will change from one crack to the other, and the other principal direction will take over the extension of the crack.

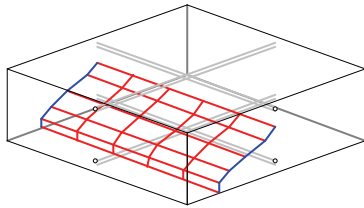

Unidirectional Moment and matching out-of-plane shear.  
 This is the traditional 2D case of loading taken care of by Response-2000

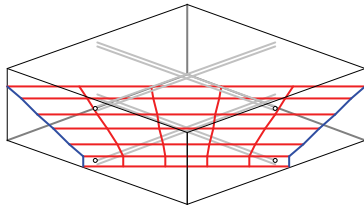

Biaxial Moment same sign, with out of plane shear.  
 Note the difference between this and the case without out of plane shear. In this case the crack rotates around to follow the direction of principal shear rather than maintaining a pair of orthogonal flexural cracks.

### *Shell-2000 Load-Deformation Plots*

Like Response-2000, Shell-2000 has a series of plots that will show overall sectional behaviour. The vertical axis on these plots is either the applied load or, if zero for the individual graph, the load-factor. Note that by using the methods explained in Section 5-2 for copying data from charts, any other combination of graphs may be made from the existing plots using a spreadsheet. The following plots are included:

- X Axial Force VS longitudinal X strain
- Y Axial Force VS longitudinal Y strain
- In-Plane (XY) Shear Force VS XY shear strain
- Moment-X VS Curvature X
- Moment-Y VS Curvature Y
- Twisting Moment ( $M_{xy}$ ) VS twisting strain
- Out of Plane X-Z shear VS X-Z shear strain
- Out of Plane Y-Z shear VS Y-Z shear strain

## SECTION V: Advanced Topics

The topics in this section are not required in order to use the programs, but can be useful to get the most out of their operation.

### 5-1 Text Effects

In entering chart titles, axes, text boxes etc, it is possible to use superscripts, subscripts and Greek characters. This works as follows:

A character (letter) preceded by an underscore (“\_”) will be a subscript.

A character preceded by a carat (“^”) will be superscript

A character preceded by a vertical bar (“|”) will be a Greek character.

For example, the following series of letters in a text box “a\_bc^d|e|f” would be shown on the screen as:

$a_b c^d \epsilon \phi$

### 5-2 Chart Options

As is likely fairly clear, the basic unit of information in the programs is the chart. As such, there are a number of features available in using charts that are accessed by right clicking on the charts themselves. The following 6 options are available on right-clicking:

#### i) Copy Chart Picture

This will copy the graph image to the clipboard so that it can be pasted into other applications. This function was used extensively, for example, in making this manual.

#### ii) Copy Chart Data

This will copy the data from a chart to the clipboard in the form of a table of numbers. This allows the data to be pasted into a spreadsheet for further analysis. Note that the data as entered will have to be “parsed” in order to put it in columns.

#### iii) View Data

This will show the chart data in a dialog box. This is useful for a simple look at the data contained without having to copy and paste it.

#### iv) Properties

This allows editing of the limits, fonts, titles etc of a chart. See section 5-3 below.

#### v) Auto/Max Range

This will change the axis mode of the chart. Normally charts automatically re-scale the axes so that the data fits nicely on the chart. When switched to max scaling, the

chart will “remember” the maximum scale values so far. This is useful when scanning through all the results with the control plot. This function is duplicated with the “auto range” button on the left side of the screen above the control plots that works on all charts simultaneously.

#### vi) Toggle Text

Each plot has the ability to show text information just below it. For plots such as longitudinal strain across the depth, it will show the curvature. For shear strain distributions, it will show the average shear strain value. For plots that show a crosshair that corresponds to the control plot, the co-ordinates of the crosshair will be shown. For other plots, it will show the average X value of the data.

### 5-3 Edit Chart Properties

An important option from right clicking on the chart is the properties page as briefly noted above. This brings up a dialog box as shown below that allows many parts of the chart to be changed. This can be useful to optimise the appearance of plots before printing. If it is desired to make more substantial changes to a plot, it will be necessary to copy the data to a spreadsheet, as explained above, and recreate the graph there.

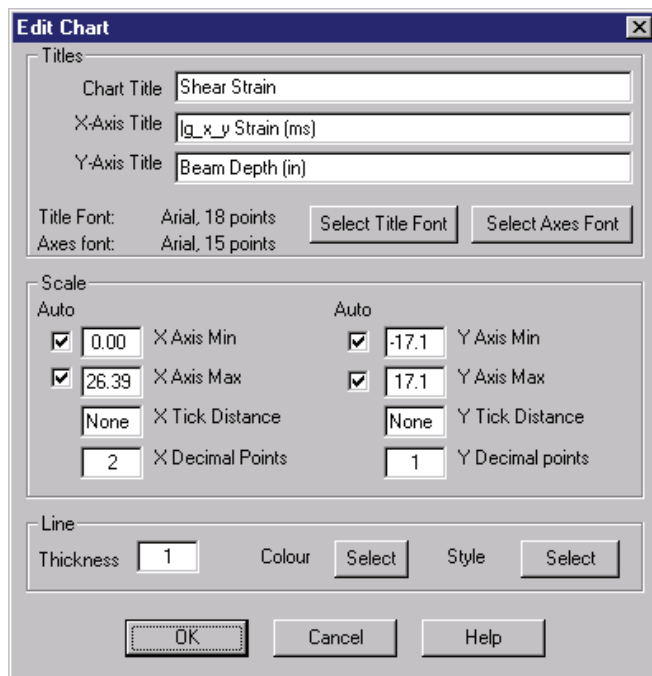

The dialog box has three parts to it. The top deals with the titles, the middle deals with the scaling of the data, and the bottom deals with the appearance of the primary line on the chart. The example here shows a shear-shear strain graph from Response-2000.

#### *Title Section*

The chart title, X-axis title and Y-axis title may be changed here. Note that the methods explained above for super/subscripts and Greek characters may be used (which may explain why the text may look strange for some charts). The small

charts used in the 9-plot output don't show their axis titles, but they are stored here anyway so that units and axes may be confirmed. The user can change the fonts for the title and axes from this part of the dialog box as well.

#### *Scaling of Data Section*

The scaling of the data has a number of options. For the X and Y direction the user can select the minimum and maximum axis values, the tick-mark spacing (or None as shown) and the number of decimals to show. The graph min and max values have

check boxes for automatic scaling. That will scale things so that everything fits in well. When copying data to the clipboard or for viewing, the number of decimal points presented is increased from the listed value by 2.

#### *Line Section*

This allows changes to the appearance of the line itself. The thickness of the line may be adjusted to any integer. The colour of the line may be changed as well. The third option allows changing the type of line, normally a solid line with four other choices available. For graphs with more than one line on them, these changes will only affect the first line.

### **5-4 Double Click Information in Response-2000**

In Response-2000, but not the other programs, double clicking on the background behind the main cross section drawing will bring up a dialog box with calculated information about the cross section. This information includes:

- Total Area of Reinforcement above and below mid-depth of beam
- List of number of actual bars present (e.g. 6 #4)
- Estimate of effective depths  $d$  and  $d'$ .
- Gross percentage of steel. This is calculated as  $A_s/A_c$ , not  $A_s/bd$ .
- Maximum transverse reinforcement level Complex geometry can trick This calculation, so care is required when interpreting it.
- AASHTO-94 Shear Strength/AASHTO-99 Shear Strength
  - This is based on the loading ratios in the “Loads | Loads” dialog box.

### **5-5 Segmental Concrete Model**

One of the concrete material models is called the segmental model. The user is asked for a list of stress-strain pairs when they click the “modify” button in the concrete dialog box. There are a number of restrictions in using this. Firstly, only one segmental type may be used per input file. More importantly, the stress-strain curve will only be saved in Response-2000 files; Membrane-2000, Shell-2000, and Triax-2000 can use the segmental model, but cannot save the data in their output files.

### **5-6 Material Reduction Factors**

Some design codes such as the Canadian concrete building code treat strength reduction factors not on the calculated sectional strength, but on the material properties themselves. This is supported in the programs through the “Options | Preferences” menu option. There is a button there that will automatically select the factors for the CSA code as well as another button that will remove the factors. If the numbers are listed as 1.0, then they have no effect on the analysis. In printing out factored results in this way, there will generally be an “f” tacked onto the end of the title of a force, for example,  $M$  becomes  $M_f$  when it’s factored.



### 5-7 Concrete Strain Discontinuity Example

This is included here, as it would tend to be too confusing above. A strain discontinuity allows the basic assumption of plane-sections remaining plane to be violated in Response-2000 for situations such as composite construction. This case is important when a slab is cast onto an unshored beam. In that case, the beam will have its own dead load as well as the load of the wet slab concrete placed onto it when there is no stress at all in the slab. Any additional loading will then take place in a composite fashion with the slab. The following example demonstrates how to account for this case for the simple 80 foot beam described in the “Quick Start: Response-2000” in section I.

Start with the beam and no slab or slab reinforcing. This should look like the following figure. It isn’t important that the stirrups come out of the precast beam, though it would be important if there were longitudinal steel bars outside the cross section.

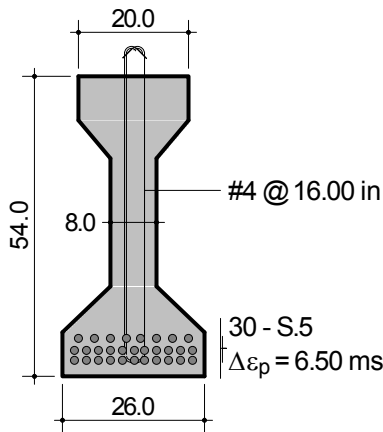

Suppose that the top slab is added when the loading causes a moment at the location of interest of 1070 ft.kips. From a simple moment analysis with no shear or axial load, this corresponds to a top strain of  $-0.1593$  mm/m, and a bottom strain of  $-0.375$  mm/m. The stress at the top of the beam is 610 psi compression and bottom stress is 1428 psi compression. Note that these numbers can be obtained by double clicking on the plots or by right clicking and selecting “view data.”

To account for the slab, extrapolate the linear strain profile into the location of where the slab will be. If the slab were to be 8 inches deep, placed directly on top of the beam, the strain in the bottom of the slab would equal the above value of  $-0.1593$  mm/m, and the strain at the top of the slab would equal  $-0.1273$  mm/m.

Now enter in the slab itself, 80 inches wide and 8 inches thick. For this example, 2 layers of 10 #4 bars will be added to the top slab as well as per the original design in

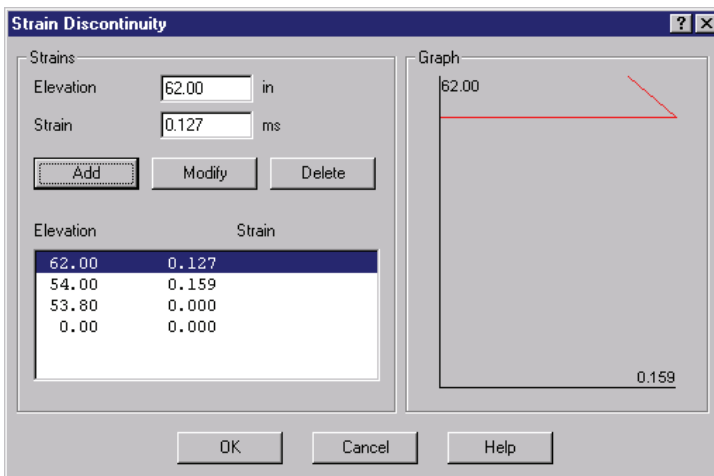

Section I. Next, go to the “Loads | Strain Discontinuity” page. Enter a strain at a depth of 62 inches (the top) of  $+0.1273$  mm/m (i.e. the opposite sign of what was calculated above.) Also, enter a strain at 54 inches of  $+0.1593$  mm/m. Just slightly below this depth, say 53.8 inches, add in a point of zero strain so there won’t be any change to the

precast beam. The graph in the discontinuity box should look like the figure.

Now perform a new moment-curvature analysis or, better, a one-load analysis at the old moment of 1070 kip.ft. The effect of the strain discontinuity is shown in the two figures below.

The strain graph shows that while plane sections are still plane, there is an offset that happens to make the strain equal to zero in the top slab section up to the top of the axis. The effect of this on the stress plot is that there is no stress in the slab. This means the stress in the beam is still the same as it was before the addition of the slab, and there is no stress in the slab itself.

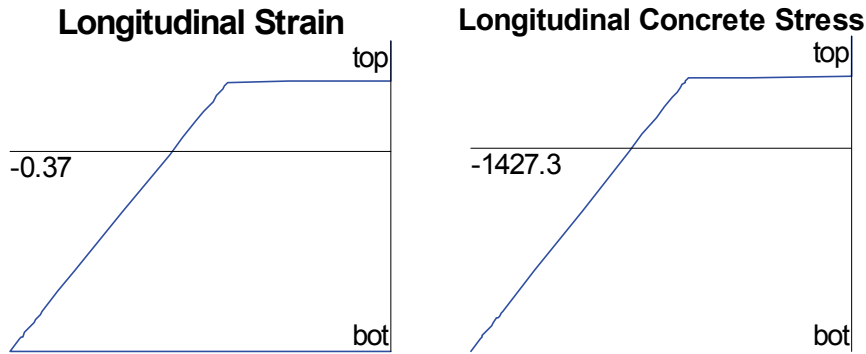

As the load increases, say to 2000 kip.ft, the following plots are obtained. The strains increase beyond the state above. This means that incrementally, plane sections remain plane, as they should be for fully composite materials.

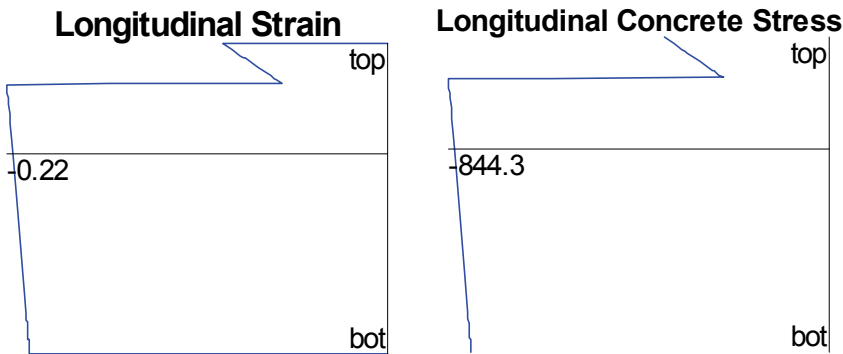

## 5-8 Rebar.dat

Each of the programs has a list of reinforcing bar definitions that can be used by any cross section (see Table 2-4 in section II). This list is, in fact, user definable. Each program maintains a file in its install directory called "rebar.dat" that is a text file loaded each time the program starts. Users may add to this list and the new options will be available the next time the program is started. Note that each program has a separate rebar.dat, but they are all identical on distribution. (i.e. if changes are made to one, they can be copied to the directories of the other programs as well.)

The format of the file is as follows:

```
// Response-2000 Data File
//
// This file contains the definitions of all standard rebar/strand types
//
// Users may add more types which will be available the next time that
// Response-2000 is started. Input is not case sensitive.
//
// If bars are entered with the same name as existing ones, the first one will be used
// Bar title is limited to 14 characters. Spaces are allowed, but the first number
// found after the title and a space is assumed to be the area.
//
// Information is as follows:
//
// Name code      Nominal Diameter (mm)      Nominal Area (mm^2)
//
// -- start of default listing --
//
// CSA standard Reinforcing Bars
//
10M  11.3  100
15M  16.0  200
20M  19.5  300
25M  25.2  500
30M  29.9  700
35M  35.7  1000
... etc
```

If a file including a user defined bar is used on a version of one of the programs that has not seen the bar title before, the new name will be saved to the standard listing when the program shuts down.

## 5-9 Adding predefined shapes: Shape.dat

The list of basic shapes used in the concrete definition in Response-2000 is user extendable. This may be useful for things such as design optimisation where the same geometry may be tweaked by adjusting only one or two variables.

The format of this file is shown with the simple example of a rectangle and a more complex example of an interlocking spiral chamfered rectangle.

```
// This file defines all the simple shapes used by Response-2000
// note that the standard shapes (PCI etc) are located in standard.dat
//
// Users can add more shapes to end of this file. They will be available
// the next time the program is loaded
//
// The format here is defined as follows:
//
// TYPE name      title of section
// line          one text line describing the section
// name.ico      (optional) name of icon from current directory to use
//              (if not included a default user icon will be used)
// PARAMS b h    variable names to define the shape
// lines        one line for each variable as text definition
// SECTION      start of the section definition
//   height width one line for each change in geometry
//              simple math is allowed (+ - * / )
// REBAR RECT   rebar pattern symbols allowed: RECT, POLAR, BIPOLAR
//              RECT means rectangular reinforcement (like a beam)
//              POLAR means circular (like in a round column)
//              BIPOLAR means interlocking spirals pattern
// ENDTYPE     indicating end of the list
//
// half circles and elliptical parts can be defined as:
//
//   height width
//   code
//   height width
//   with code = UP or DOWN indicating which side has the zero slope
//
// Absolute dimensions in mm. Distance from bottom of section
// lines starting with 2 slashes are comment lines
//
TYPE RECT
    Rectangle Section
PARAMS b h
    Width of the Rectangle
    Height of the Rectangle
SECTION SOLID
    h b
    0 b
REBAR RECT
ENDTYPE
//
TYPE INTER
    Interlocking Spiral Column
    inter.ico
PARAMS b h bt
    Total section width
    Total section height
    Width at top and bottom extremes
SECTION SOLID
    h bt
    h-(b-bt)*0.5 b
    (b-bt)*0.5 b
    0 bt
REBAR BIPOLAR
ENDTYPE
```

## 5-10 Adding predefined sections: Standard.dat

This file is very similar to the shape.dat file explained above except that it does not allow variables to define the section. It is used to define standard sections such as the AASHTO highway girder cross sections.

The format of the file is listed here.

```
// Response-2000 input file
//
// This file contains all the standard sections for Response
//
// Users can add more to end of file as well with the following format
//
// TYPE name          name is the unique identifier for the section
// CATEGORY name      name of category ex PCI hollowcore
// SECTION            indicating start of section list
//   b h              as many lines as needed to define the section
// ENDTYPE            indicating the end of the listing
//
// half circles and elliptical parts can be defined as:
//
//           height width
//           code
//           height width
//
//           with code = UP or DOWN indicating which side has the zero slope
//
// Absolute dimensions in mm. Distance from bottom of section
// lines starting with 2 slashes are comment lines
//
// Order of definition is maintained.
//
// see the default types below for examples
//
//
TYPE CPCI900
CATEGORY CPCI-I
SECTION SOLID
           900 300
           750 300
           720 150
           240 150
           150 450
           0  450
ENDTYPE
//
```

## 5-11 Template Files

When the programs are started, they look automatically for a template file, to load up default values for the program to run with.

Program	Template File
Response-2000	r2k.r2k
Membrane-2000	m2k.m2k
Shell-2000	m2k.m2k
Triax-2000	t2k.t2k

The template file must be located in the directory of the program itself. The following parameters are set from the template file:

Default units  
Default name for the “done by” part of input files  
Default steel yield stress  
Default aggregate size  
Default concrete strength

To create a template file, simply make an input file that has all the desired base components generally wanted in a starting file. For some, this may include material types, concrete geometry, loading, units, etc. Save this file in the program install directory with the name listed above. Upon restarting the program, it should automatically load this new file. Note that Response-2000 will automatically rename the file “r2k.r2k.rsp” as .rsp is the standard file extension for Response-2000. This means that the Response template file must be renamed by hand using, for example, the windows explorer.

This is the simplest way to have the program begin each time with, say, Japanese units rather than SI metric, which is the default starting units.

## 5-12 Text File Formats

The binary file formats used in the programs may be requested from the author at the University of Toronto at the address on page 1.

Response-2000 also supports a text-based file format that supports all the features of the full binary version of the program. What follows is a definition of this format with an example as well.

### Usage

This file format can be transparently used in Response-2000. The existing load dialog box in Response-2000 allows access via the "files of type" option.

### Extension

Filename extension is ".r2t" (Response-2000 text file).

### Contents:

The following is a comprehensive list of the contents of the file. Note that options within square brackets ([ ]) are optional and Response-2000 will assumed default numbers for them if not provided. Lines preceded by a "#" or "/" are comment lines and may be inserted at will.

### Version:

The format described herein represents Response file format number 0.8. This version type will remain supported for all released versions of Response-2000.

### Units

Units for input are listed below in order of Metric, US Customary, and Old Metric (ex mm,in,cm means millimetres in SI metric, inches in US Customary, and centimetres for kg/cm<sup>2</sup> units)

**Formats:** the following text formats are used below

\_text1 text format type 1: no spaces [a..z,0..9,\_,-] (case insensitive)

\_text2 text format 2, any character (case sensitive)

\_units units indicator [M|USC|OLDM|METRIC|OLDMETRIC] (case insensitive)

\_fnum floating point (or integer) number

\_inum integer number

```

// Response-2000 Input File Ver_0.8           Mandatory first line
//
// arbitrary number of comment lines.
//
INPUT-LABEL _text1                           unique identifier
  [TITLE _text2]                             optional title
  [DONEBY _text2]                            optional ownership
  [DATE _text2]                              optional date
  UNITS _units                               units of input file
  [CRACKX _fnum]                             long. crack spacing. (-1 for default)
  [CRACKY _fnum]                             trans. crack spacing. (-1 for default)
  [AXIALLOC _fnum]                           location of center of axial force
  MATERIAL CONCRETE _text1                   concrete material block with name

```

Membrane-2000 Response-2000 Triax-2000 Shell-2000

```

FCP _fnum          cylinder strength (MPa,psi,kg/cm2)
[FT _fnum]         tensile strength (MPa,psi,kg/cm2)
[EO _fnum]         strain at peak stress (x10-3)
[TSFACOR _fnum]   tension stiff. factor (0.0 < fact < 1.0)
[MAXAGG _fnum]    maximum aggregate size (mm,inches,cm)
[C_MOD _inum]     concrete base curve type
                  0= linear to peak stress
                  1= parabolic curve
                  2= Popovics/Thorenfeldt/Collins
                  // note segmental not supported yet
[C_SOFT _inum]    concrete compression softening

[T_STIFF _inum]   concrete tension stiffening

ENDMAT
[... as many as 5 concrete material types in total repeating type list above]
MATERIAL REBAR _text1 First rebar definition block with name
  FY _fnum          yield stress (MPa,ksi,tons/cm2)
  [E _fnum]         Young's modulus (MPa,ksi,tons/cm2)
  [FU _fnum]        ultimate strength (MPa,ksi,tons/cm2)
  [ESH _fnum]       strain at start of strain harden(x 10-3)
  [EU _fnum]        strain at peak stress (x 10-3)

ENDMAT
MATERIAL PRESTRESS _text1 first prestressed steel type definition
  FU _fnum          ultimate strength (MPa,ksi,tons/cm2)
  [E _fnum]         Young's modulus (MPa,ksi,tons/cm2)
  [A _fnum]         Ramberg-Osgood parameter A
  [B _fnum]         Ramberg-Osgood parameter B
  [C _fnum]         Ramberg-Osgood parameter C
  [EU _fnum]        strain at peak stress (x 10-3)

ENDMAT
[. as many as a total of 20 different rebar and prestress types allowed]
SECTION SOLID define the solid cross section
  _fnum _fnum _text1 depth, width, type name (mm,in,cm)
  _fnum _fnum _text1 depth, width, type name
  [... as many as 30 different definitions as such ]
  [... alternate methodology below... use one or other]
  SECTNAME _text1  shape name from shapes.dat
  PARAMS _fnum _fnum _fnum ... variable parameters for that

ENDSECTION
SECTION HOLLOW unsupported for now

ENDSECTION
LONGTAB longitudinal steel table
  _fnum _fnum _fnum _text1 height, area, prestrain, type of steel
  [... as many layers as desired. can be used with LONGREINF or without]
LONGREINF _text1 first type of longitudinal reinforcement
  Z _fnum          depth from bottom of section (mm,in,cm)
  A _fnum          area of steel at depth (mm2,in2,cm2)
  TYPE _text1     type (either rebar or prestressed type)
  [DRAPE _fnum]   drape of reinforcement (rise over run)
  [num _fnum]     number of individual bars
  [AI _fnum]      area of individual bar
  [DB _fnum]      diameter of individual bar
  [BART _text1]   title of bar type
                  Note that we can specify num=10, bart=#5
                  or we could specify num=10, AI=200mm2, DB=16 mm
                  and get same thing. If both specified, BART precedence
  [DEP _fnum]     Delta-epsilon-p prestrain (x10-3)
                  The following allows grouping of bars. All layers must be
                  individually entered, but they can be grouped into
                  distributed patterns or circular patterns.
  [PATTERN _inum] (0= none, 1= circular, 2=distributed)
  [NROUND _inum] number in pattern
                  for pattern=1, it's number around circle
                  for pattern=2, it's total number of bars in layers
  [ALIGNED _inum] if 1, then 2 bars at top, if 0, 1 bar at
                  top for circular patterns
  [INDEX _inum]  which pattern number we are dealing with

ENDLONG
[. as many longitudinal patterns as will fit into memory allowed]

```



## Membrane-2000 Response-2000 Triax-2000 Shell-2000

```

TRANSREINF _text1      first transverse reinforcement type
  A _fnum              total area of all legs of steel
  TYPE _text1         type (either rebar or prestressed type)
  PATTERN _inum       style of type:
                      0 = single leg
                      1 = open stirrup
                      2 = closed stirrup
                      3 = hoop
                      4 = T headed single leg
  SPACE _fnum         spacing of reinforcement (mm,in,cm)
  [DISTTOP _fnum]    distance from bottom of section to top
                    of reinforcement (mm,in,cm)
  [DISTBOT _fnum]    distance from bottom of section to
                    bottom of reinforcement (mm,in,cm)
  [AI _fnum]         area of individual bar
  [DB _fnum]         diameter of individual bar
  [BART _text1]      title of bar type
                    Note that we can specify bart=#5
                    or we could specify AI=200mm2, DB=16 mm
                    and get same thing.  If both specified, BART precedence
  [DEP _fnum]        Delta-epsilon-p prestain (x10-3)
ENDTRANS
LOADING
  [CONSTANT _fnum _fnum _fnum] constant load component
  [VARIABLE _fnum _fnum _fnum] variable load component
ENDLOAD
[SHRINKTHERM CONCRETE]
  [_fnum _fnum]      depth and shrinkage amount
                    (mm,in,cm), (x 10-3)
  [.. as many layers of shrinkage as desired for concrete]
[ENDSHRINK]
[THERMAL REINFORCE]
  (not supported yet)
  [_fnum]            thermal strain for each long. type
[ENDSHRINK]
[DISCONT]
  [_fnum _fnum]      depth and discontinuity strain
  [.. as many as wanted]
[ENDDISCONT]
ANALYSIS
  TYPECODE _inum _fnum _fnum  type of analysis to perform
                              and input values as listed
                              0 = none
                              1 = full response
                              2 = one load
                              3 = 2 strain solution
                              (params strain,depth, strain depth)
                              4 = 1 strain solution
                              (params strain depth)
                              5 = M-N Interaction
                              6 = M-V Interaction
                              7 = N-V Interaction
                              8 = Pushover analysis
  [.. as many analyses as desired for this section]
  [ only used for command line version of response. Send email]
ENDANALYSIS
[MEMBERINFO]
  [L _fnum]          length of shear span (mm,in,cm)
  [MIDO02 _fnum]    middle length of constant moment
                    mm,in,cm)
  [TYPE _inum]      type of loading
                    1= constant shear analysis
                    2= UDL beam type
                    3= UDL footing type
  [LEFTPERCENT _fnum] left side % moment of right side (%)
  [LEFT _inum]      left side loading
                    1= support on bottom
                    2= support on top
                    3= Fixed support
  [RIGHT _inum]     right side support
                    1= load on top

```

## Membrane-2000 Response-2000 Triax-2000 Shell-2000

---

```

                [PENETRATE _fnum]          2= load on bottom
                [ENDMEMB]                  3= fixed column base
                                          yield penetration. 0.022 suggested
ENDINPUT
[more input-labels may be place here to as many as desired.]

Examples: simple t beam shear analysis

// Response-2000 Input File Ver_0.8
//
// this is a sample T-Beam analysis for shear
//
INPUT-LABEL T_TEST
  TITLE T beam test
  DONEBY Evan Bentz
  DATE 99/03/09
  UNITS Metric
  MATERIAL CONCRETE concrete
        FCP 35
        MAXAGG 19
  ENDMAT
  MATERIAL REBAR steel
        FY 400
  ENDMAT
  MATERIAL PRESTRESS prestress
        FU 1860
  ENDMAT
  SECTION SOLID
        1000 1200
        800 1200
        800 300
        0 300
  ENDSECTION
  LONGREINF bottom
        Z 75
        A 1500
        TYPE steel
        BART 25M
  ENDLONG
  LONGREINF top
        Z 943
        A 400
        TYPE steel
        BART 10M
  ENDLONG
  TRANSREINF trans
        A 200
        TYPE 2
        SPACE 250
        BART 10M
  ENDTRANS
  LOADING
        VARIABLE 0 1 0 // i.e. pure moment
  ENDLLOAD
  ANALYSIS
        TYPECODE 4 2 75
//        (i.e. strain of 2.00 x 10-3, 75 mm from bottom of section)
  ENDANALYSIS
ENDINPUT

```

## References

- 1 Vecchio, F.J. and Collins, M.P., "The Modified Compression Field Theory for Reinforced Concrete Elements Subjected to Shear", *ACI Journal, Proceedings V. 83* No. 2, March-April 1986, pp. 219-231.
- 2 Bentz, E.C., "Sectional Analysis of Reinforced Concrete", *PhD Thesis, Department of Civil Engineering, University of Toronto, 2000.*
- 3 Vecchio, F.J. and Collins, M.P., "Response of Reinforced Concrete to In-Plane Shear and Normal Stresses", *Publication No. 82-03*, Department of Civil Engineering, University of Toronto, Mar 1982, 332 pp.
- 4 Kirschner, U. and Collins, M.P., "Investigating the Behaviour of Reinforced Concrete Shell Elements", *Publication No 86-09*, Department of Civil Engineering, University of Toronto, Sept 1986, 209 pp.
- 5 Collins, M.P. and Mitchell, D., "Prestressed Concrete Structures", Prentice-Hall 1991 760 pp.
- 6 Vecchio, F.J, Collins, M.P., "Compression Response of Cracked Reinforced Concrete," *ASCE Journal of Structural Engineering*, Vol 119, No. 12 Dec 1993 pp. 3590-3610.
- 7 Kolleger, J., Mehlhorn, G., "Material Model for Cracked Reinforced Concrete," *IABSE Colloquim on Computational Mechanics of Concrete Structures: Advances and Applications*, Delft, 1987. Report No. 54, pp 63-74.
- 8 Miyahara, T., Kawakami, T. Maekawa, K., "Nonlinear Behaviour of Cracked Reinforced Concrete Plate Elements under Uniaxial Compression," *Proceedings, Japan Society of Civil Engineers*, Vol. 11, pp 306-319.
- 9 Mikame, A., Uchida, K., Noguchi, H., "A Study of Compressive Deterioration of Cracked Concrete," *Proceedings, Internationsl Workshop on FEA of RC*, Columbia University, New York, 1991.
- 10 Belarbi, A, and Hsu, T.T.C, "Constitutive Laws of Reinforced Concrete in Biaxial Tension-Compression", *Research Report UHCEE 91-2*, Department of Civil and Environmental Engineering, University of Houston, Houston, Texas. 155 pp.
- 11 Collins, M.P., "Towards a Rational Theory for RC Members in Shear", *Journal of the Structural Division, American Society of Civil Engineers*, Vol 104, No. ST4, April 1978, pp. 649-666.

- 12 Kaufmann, W. "Strength and Deformations of Structural Concrete Subjected to In-Plane and Normal Forces.", *Dissertation*, Institute of Structural Engineering, ETH, Zurich, Switzerland, 1998.
- 13 Porasz, A. "An Investigation of the Stress-Strain Characteristics of High Strength Concrete in Shear", M.A.Sc. Thesis, University of Toronto 1989.
- 14 Zhang, L.-X, "Constitutive Laws of Reinforced Concrete Membrane Elements with High Strength Concrete", *PhD Thesis*, University of Houston, August 1995.
- 15 Hsu, T.T.C, "Unified Theory of Reinforced Concrete", CRC Press, Inc, Boca Raton, 1993, 336 pp.
- 16 Collins, M.P. and Mitchell, D., *Prestressed Concrete Basics*. Canadian Prestressed Concrete Institute, 1987.
- 17 Izumo, J. Shin, H. Maekawa, K., Okamura, H., "An analytical Model for RC Panels Subjected to In-Plane Stresses," *Concrete Shear in Earthquake*, Elsevier Applied Science, London and New York, 1992, pp.. 206-215.
- 18 Tamai, S. Shima, H., Izumo, J. and Okamura, H., "Average Stress-Strain Relationship in Post Yield Range of Steel Bar in Concrete." *Concrete Library of JSCE*, No. 11, June 1988, p. 117-129. (Translation from Proceedings of JSCE, No. 378/V-6, Feb 1987).
- 19 AASHTO LRFD Bridge Design Specifications and Commentary, "First Ed., American Association of State Highway Transportation Officials, Washington, 1194, 1901 pp. aashto code
- 20 Zhang, L-X, and Hsu, T.T.C., "Behavior and Analysis of 100 MPa Concrete Membrane Elements," *Journal of Structural Engineering*, ASCE, Vol 124 No. 1, 1998, pp 24-34.rastm-98
- 21 Pang, X.B. and Hsu, T.T.C. "Fixed Angle Softened Truss Model for Reinforced Concrete", *ACI Structural Journal*, V 93, No 2., Mar. Apr. 1996, pp. 197-207
- 22 Hsu, T.T.C, and Zhang, L-X., "Nonlinear Analysis of Membrane Elements by Fixed-Angle Softened-Truss Model." *ACI Structural Journal*, Vol. 94, No. 5, Sept-Oct 1997. pp 483-492.
- 23 ASCE-ACI Committee 445, "Recent Approaches to Shear Design of Structural Concrete." *ASCE, Journal of Structural Engineering*, Vol. 124, No. 12, 1998, pp. 1375-1417.fastm 98 state of the art report.
- 24 Aregawi, M., "An Experimental Investigation of Circular Reinforced Concrete Beams in Shear," M.A.Sc. Thesis, Department of Civil Engineering, University of Toronto, 1974, 86 pp.

Membrane-2000 Response-2000 Triax-2000 Shell-2000

---

- 25 Shioya, T., Iguro, M., Nojiri, Y., Akiyama, H., and Okada, T., "Shear Strength of Large Reinforced Concrete Beams. Fracture Mechanics: Application to Concrete, SP-118, American Concrete Institute, Detroit, 1989, 309 pp.
- 26 Adebar, P.E. and Collins, M.P. "Shear Design of Concrete Offshore Structures." ACI Structural Journal, Vol. 91, No. 3, 1994, pp. 324-335.